



**Silicone Materials for  
Electronic Devices  
and Component Assemblies**



## Contents

- Overview.....1-2
- Industry Overview.....3-4
- Product Index
  - Adhesives and Sealants.....5-6
  - Grease.....7
  - Coating Materials.....7-8
  - Encapsulants / Potting Materials.....9-10
- Selection Guide.....11-12
- Product Details
  - 1 Part Condensation Cure.....13-17
  - 1 Part Heat (Addition) Cure.....18-20
  - 2 Part Room Temperature. Cure.....21-22
  - 2 Part Heat (Addition) Cure.....23-24
  - 1 Part & 2 Part Gels.....25-26
  - Junction Coating Resin (JCR) Grades.....27
  - Grease.....28
- UL Certifications.....29-30
- Technical Information.....31-32
- FAQ.....33

## Silicone Product Profile

The products introduced in this selector guide consist of RTV (Room Temperature Vulcanizing) silicone products that are commonly found in Electric and Electronic applications and component assemblies. This family of silicone products consists of both **Room Temperature Cure** and **Heat (Addition) Cure** grades.

Momentive Performance Materials offers a comprehensive portfolio of silicone solutions to help meet a broad array of handling and performance needs in electronic components and assemblies. Selection of the appropriate type of RTV depends upon the required manufacturing process, handling requirements, curing conditions, equipment, and desired material properties.

### Condensation Cure

Condensation cure silicone products cure when exposed to moisture in the environment at room temperature. These materials are categorized into Alkoxy, Acetoxy, or Oxime based on the byproducts that occur during cure.

### Heat (Addition) Cure

Heat cure grades cure upon exposure to elevated heat or room temperature.

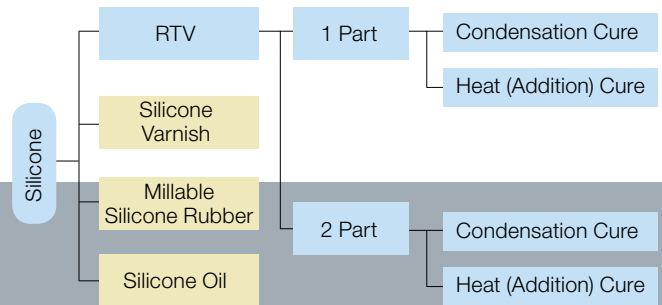

## Relative Performance Characteristics

Property	Silicone RTV	Epoxy	Urethane
Temperature Range	-50 ~ +200 °C	-50 ~ +150 °C	-30 ~ +120 °C
Heat Resistance	Good	Poor	Poor
Flame Retardancy <sup>1</sup>	Good	None	None
UV Stability	Good	Poor	Poor
Ozone Stability	Good	Poor	Poor
Modulus	Low	High	High

<sup>1</sup>As a base material silicone demonstrates flame retardant properties comparable to UL94HB.



## Sealing & Adhesion

Silicones are used in a wide array of applications for bonding components, and sealing against moisture or environmental contaminants. A comprehensive portfolio of 1 Part and 2 Part Adhesives and Sealants, many of which are excellent candidates for assembly applications on or near sensitive electrical and electronic components, are available. These materials are applied by a variety of methods ranging from manual dispensing to auto-dispensing units for tube, cartridge, pail, or drum packages. Mixing for 2 Part grades may be accomplished by either manual processes



or meter mix dispensing, depending on production volume and post-mix material properties.

### Performance Considerations

- Temperature Resistance
- Dielectric Resistance
- Flame Retardancy
- Low Volatility
- Adhesion
- Mechanical Strength
- Hardness
- Thermal Conductivity

### Process Considerations

- Viscosity
- Cure Mechanism
- Cure Temperature
- Cure Time
- Pot Life

## Coating

The Coating process involves the application of silicone in a thin protective layer to a component surface by methods such as dip, flow, spray, and selective robotic



coating. Selection of a silicone coating material for a particular application involves the consideration of various performance and processing criteria.

### Performance Considerations

- Temperature Resistance
- Dielectric Resistance
- Flame Retardancy
- Low Volatility

### Process Considerations

- Viscosity
- Cure Mechanism
- Cure Temperature
- Cure Time
- Pot Life

## Potting & Encapsulation

Silicone rubber and gels are widely used in electronics to ensure mechanical and environmental protection. A full range of products are offered in various cure speeds, viscosities, and

performance, many of which offer enhancements for thermal cycling protection, stress relief, material strength, flame retardancy, or optical clarity.



### Performance Considerations

- Temperature Resistance
- Dielectric Resistance
- Flame Retardancy
- Low Volatility
- Adhesion
- Stress Relief
- Release Properties
- Thermal Conductivity

### Process Considerations

- Viscosity
- Cure Mechanism
- Cure Temperature
- Cure Time
- Pot Life



## Industries Served

### Electronic Devices and Power Modules

Momentive Performance Materials is a driving force as a supplier of advanced silicone technology to the electronics industry. Increasing electronic component densities and performance demands have created a need for specialized silicone solutions from Momentive for a broad mix of performance and handling requirements.

#### Typical Applications:

- Power converters
- Inverters
- Hybrid ICs
- Micro-Electronic packaging
- High-voltage component insulation
- Membrane switches
- Photo couplers

### Board Assembly

Silicones are found in board-level adhesion, coating, and encapsulation applications, and contribute to the long-term, reliable performance of many components and assemblies. A wide portfolio of products is available, providing flame retardancy, thermal conductivity, temperature resistance, low-volatility, or high-purity benefits.

#### Typical Applications:

- Board-level adhesion, fixing, and sealing
- PCB coating
- Component encapsulation
- Junction Coating Resins

### Consumer Electronics

Silicones are commonly used in a variety of consumer electronics applications. In addition to providing adhesion to many substrates, an array of grades are available to provide heat resistance, flame retardancy, low volatility for sensitive components, and moisture protection.

#### Typical Applications:

- Flat panel displays
- PCs and Smart Phones
- LED Lighting
- Air conditioner units
- Control panel insulation
- PCB fixing and sealing



### Automotive Electronics

The automotive industry plays a critical role in integrating new electronic technologies. As more and more components migrate to electronic solutions, silicones play an increasingly important role in helping deliver material solutions that contribute to design flexibility and long-term component reliability under harsh operating conditions.

### Typical Applications:

- ECU potting, sealing, coating
- Wire connector sealing
- Sealing, encapsulation in a broad range of sensors
- HVAC system sealing
- Vibration dampening
- Headlamp assemblies



### Aviation and Aerospace

Avionics and frame assembly needs in Aviation and Aerospace are served through silicone adhesives, coating, encapsulation and potting materials that help withstand stress and temperature extremes.

### Typical Applications:

- Avionics
- Circuit and terminal protection
- Wire sealants
- Engine gasketing
- Cargo door, window sealing
- Weatherstrip adhesives
- Aviation lighting
- Ventilation ducts



### Energy

Reliability of electronic components and the ability for panels to withstand harsh conditions over the lifecycle of the product are important considerations in solar energy applications. Momentive Performance Materials helps serve this growing industry with its range of potting materials and sealants.

### Typical Applications:

- Terminal box potting
- Box and base sealing
- Aluminum frame and glass / EVA plate sealing

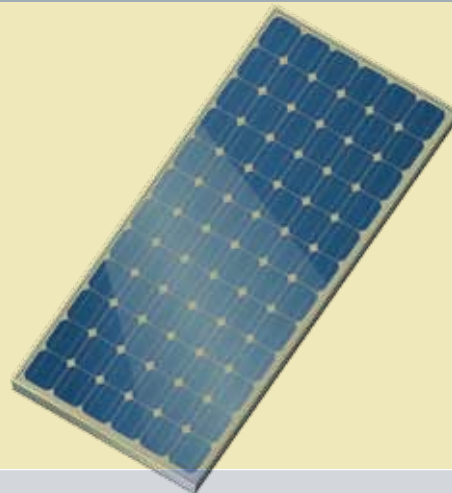

## Product Overview: Adhesives & Sealants

Type	Grade	Cure Chemistry	Cured Property	Feature
1 Part Condensation Cure	RTV133	Alkoxy	Rubber	UL certified non-flowable sealant.
	RTV167	Alkoxy	Rubber	High-strength paste adhesive with UL certification and Mil Spec.
	TSE385	Alkoxy	Rubber	Paste adhesive.
	TSE3853-W	Alkoxy	Rubber	UL certified, semi-flowable paste.
	TSE3854DS	Alkoxy	Rubber	UL certified paste adhesive.
	TN3005	Alkoxy	Rubber	Fast tack, low volatile paste paste adhesive.
	TN3085	Alkoxy	Rubber	Fast tack, low volatile paste paste adhesive. UL certified
	TSE3941M	Alkoxy	Rubber	Fast tack, thermally conductive flowable sealant.
	TSE3944	Alkoxy	Rubber	Low volatile, UL certified flowable sealant.
	TN3305	Alkoxy	Rubber	Fast tack, low volatile flowable adhesive / sealant. UL certified
	TSE3971	Alkoxy	Rubber	Flowable adhesive / sealant.
	TSE3976-B	Alkoxy	Rubber	Low volatile, temperature resistant sealant. UL certified.
	XE11-B5320	Alkoxy	Rubber	Fast tack, low volatile, thermally conductive adhesive. UL certified.
	FRV1106	Acetoxo	Rubber	Fuel, solvent, chemical, and temperature-resistant fluoro sealant.
	RTV100 series	Acetoxo	Rubber	FDA, USDA, and NSF compliant paste adhesive. Mil Spec.
	RTV106	Acetoxo	Rubber	Temperature-resistant adhesive. FDA, USDA, & NSF compliant. Mil Spec.
	RTV116	Acetoxo	Rubber	Temperature-resistant flowable sealant. FDA, USDA, & NSF compliant. Mil Spec.
	RTV157	Acetoxo	Rubber	High strength paste / adhesive.
	RTV159	Acetoxo	Rubber	High strength paste / adhesive. Temperature-resistant.
	TSE370	Acetoxo	Rubber	Fast tack, general purpose paste adhesive.
	TSE382	Oxime	Rubber	Fast tack, general purpose adhesive paste. UL certified.
	TSE3826	Oxime	Rubber	Fast tack adhesive for high-temperature applications.
	TSE3843-W	Oxime	Rubber	UL certified general purpose adhesive / sealant.
	TSE384-B	Oxime	Rubber	UL certified general purpose adhesive / sealant.
	TSE387	Oxime	Rubber	General purpose flowable adhesive / sealant.
	TSE3877-B	Oxime	Rubber	Flowable sealant for high-temperature applications.
TSE388	Oxime	Rubber	Flowable general purpose adhesive / sealant.	
1 Part Heat Cure	TSE3212	Heat	Rubber	Thixotropic adhesive / sealant.
	TSE322	Heat	Rubber	Flowable adhesive / sealant.
	TSE3221S	Heat	Rubber	Flowable adhesive / sealant.
	TSE322S	Heat	Rubber	UL certified, semi-flowable adhesive / sealant.
	TSE326	Heat	Rubber	UL certified, high temperature-resistant adhesive / sealant.
	TSE3261-G	Heat	Rubber	High temperature-resistant adhesive / sealant.
	TSE326M <sup>1</sup>	Heat	Rubber	High temperature-resistant adhesive / sealant.
	TSE3280-G	Heat	Rubber	Thermally conductive adhesive.
	TSE3281-G	Heat	Rubber	Thermally conductive adhesive.
	XE13-B3208	Heat	Rubber	General purpose adhesive / sealant.
LA650S	Heat	Rubber	Adhesive that cures to a tough silicone elastomer.	
RT 2P	RTV577	Condensation	Rubber	Extreme low temperature resistant sealant. Release capability.
	RTV88	Condensation	Rubber	Semi-flowable temperature-resistant sealant. Release capability.
Heat 2P	TSE3360	Heat	Rubber	General purpose adhesive / sealant with extended pot life.
	TSE3380	Heat	Rubber	Thermally conductive adhesive. Fast cure at elevated temperatures.

<sup>1</sup> TSE326M-EX in Europe and the Americas

Performance									Product Detail
Flowability	Flame Retardancy	Low Volatility	Thermally Conductive	High Temp. Resistance	Low Temp. Resistance	FDA Compliant	MIL-Spec		
Non-flowable	UL94 V-0								P. 13
Non-flowable	UL94 HB							MIL-A-46146B	P. 13
Non-flowable									P. 13
Semi-flowable	UL94 V-0								P. 14
Non-flowable	UL94 V-0								P. 13
Non-flowable		●							P. 13
Non-flowable	UL94 V-0	●	●						P. 13
Flowable			●						P. 14
Semi-flowable	UL94 V-0	●							P. 14
Flowable	UL94 HB	●							P. 14
Flowable									P. 14
Flowable	UL94 HB	●			●				P. 14
Non-flowable	UL94 HB	●	●						P. 13
Non-flowable					●				P. 16
Non-flowable						●		MIL-A-46106B	P. 17
Non-flowable						●		MIL-A-46106B	P. 17
Flowable						●		MIL-A-46106B	P. 17
Non-flowable									P. 17
Non-flowable						●			P. 17
Non-flowable									P. 17
Non-flowable	UL94 HB								P. 15
Non-flowable						●			P. 16
Semi-flowable	UL94 V-1		●						P. 16
Non-flowable	UL94 V-0								P. 16
Flowable									P. 16
Flowable						●			P. 16
Flowable									P. 16
Semi-flowable									P. 18
Flowable									P. 18
Flowable									P. 19
Semi-flowable	UL94 HB								P. 18
Flowable	UL94 HB					●			P. 19
Flowable						●			P. 18
Flowable						●			P. 20
Flowable			●						P. 19
Flowable			●						P. 19
Non-flowable									P. 18
Non-flowable									P. 18
Non-flowable						●			P. 21
Semi-flowable						●			P. 21
Non-flowable									P. 23
Flowable			●						P. 23

## Product Overview: Coating Materials

Type	Grade	Cure Chemistry	Cured Property	Feature
1 Part Condensation Cure	ECC3010	Alkoxy	Rubber	Fast cure conformal coating material. Solvent free
	ECC3050S	Alkoxy	Rubber	Fast cure conformal coating material. Low volatile. Solvent free
	ECS0600	Alkoxy	Rubber	High purity repairable electrode coating. Fast tack.
	ECS0601	Alkoxy	Rubber	High purity, non-repairable type electrode coating. UL certified.
	ECS0609FR	Alkoxy	Rubber	High purity, non-repairable type electrode coating. UL certified.
	RTV160	Alkoxy	Rubber	UL certified flowable sealant.
	TSE3941M	Alkoxy	Rubber	Fast tack, thermally conductive flowable sealant.
	TSE3944	Alkoxy	Rubber	Low volatile, UL certified flowable sealant.
	TN3305	Alkoxy	Rubber	Fast tack, low volatile flowable adhesive / sealant. UL certified.
	TSE3971	Alkoxy	Rubber	Flowable sealant.
	TSE3976-B	Alkoxy	Rubber	Low volatile, temperature resistant sealant. UL certified.
	TSE398	Alkoxy	Rubber	Pourable coating / encapsulant.
	TN3705	Alkoxy	Rubber	Low volatile, low viscosity coating / potting material
	XE11-A5133S	Alkoxy	Rubber	Low volatile, UL certified, thermally conductive coating & potting.
	RTV110 series	Acetoxy	Rubber	General purpose coating / encapsulant. FDA, USDA, and NSF compliant. Mil Spec.
	TSE387	Oxime	Rubber	General purpose flowable sealant / coating.
	TSE3877-B	Oxime	Rubber	Flowable sealant for high-temperature applications.
	TSE388	Oxime	Rubber	Flowable, general purpose sealant / coating.
	TSE389	Oxime	Rubber	Flowable, UL certified coating / sealant.
1 Part Heat Cure	ECC4865	Heat	Rubber	Extreme low viscosity coating material with UV tracer.
	TSE3221S	Heat	Rubber	Flowable sealant / coating material.
	TSE325	Heat	Rubber	Flowable coating / encapsulant.
	TSE3250	Heat	Rubber	Flowable coating / encapsulant.
	TSE3251	Heat	Rubber	Flowable coating material.
	TSE3251-C	Heat	Rubber	Flowable coating material.
	TSE325-B	Heat	Rubber	Flowable coating / encapsulant.
	TSJ3155	Heat	Rubber	High purity JCR-grade white rubber.
	TSJ3195-W	Heat	Gel	High purity JCR-grade white gel.
	TSJ3185	Heat	Gel	High purity JCR-grade translucent gel.
TSJ3187	Heat	Gel	High purity JCR-grade translucent gel.	
2P RT	RTV11	Condensation	Rubber	General purpose encapsulation and potting. FDA compliant.
2 Part Heat Cure	TSE3033	Heat	Rubber	Transparent coating / encapsulant. Fast cure at elevated temperatures.
	TSE3331	Heat	Rubber	UL certified, thermally conductive, coating / encapsulant.
	TSE3331K <sup>1</sup>	Heat	Rubber	Low viscosity variant of TSE3331.
	TSE3331K EX <sup>1</sup>	Heat	Rubber	Low viscosity variant of TSE3331.
	XE14-B5778	Heat	Rubber	High purity JCR-grade translucent rubber.
	TSJ3175	Heat	Gel	High purity JCR-grade thixotropic gel.

<sup>1</sup> TSE3331K for Asia Pacific, TSE3331K EX for Europe and the Americas

## Grease - Product Index

Grade	Feature	Performance				Product Detail
		Thermally Conductive	Low Bleed	Low Volatility	Heat Resistant	
TSK5303	Moderate thermal conductivity with heat resistance.	●		●	●	P. 28
TSK5370	General electrical insulation. Swell resistant on silicone.			●		P. 28
TSK550	General electrical insulation, arc resistance.					P. 28
TSK551	Insulator protection from salt, dust.					P. 28
YG6111	Moderate thermal conductivity.	●		●		P. 28
YG6240	Moderate thermal conductivity, low-bleed performance.	●	●	●		P. 28
YG6260	Moderate thermal conductivity.	●		●		P. 28
TIG1000	High thermal conductivity.	●		●		P. 28



Performance									Product Detail
Flowability	Flame Retardancy	Low Volatility	Thermally Conductive	High Temp. Resistance	JCR Grade	FDA Compliant	MIL-Spec		
Flowable									P. 15
Flowable		●							P. 15
Flowable		●							P. 15
Flowable	UL94 HB	●							P. 15
Flowable	UL94 V-0	●							P. 14
Flowable	UL94 HB								P. 14
Flowable			●						P. 14
Semi-flowable	UL94 V-0	●							P. 14
Flowable	UL94 HB	●							P. 14
Flowable									P. 14
Flowable	UL94 HB	●		●					P. 14
Flowable									P. 15
Flowable		●							P. 15
Flowable	UL94 V-1	●	●						P. 14
Flowable						●	MIL-A-46106B		P. 17
Flowable									P. 16
Flowable					●				P. 16
Flowable									P. 16
Flowable	UL94 HB								P. 16
Flowable									P. 20
Flowable									P. 19
Flowable									P. 20
Flowable									P. 20
Semi-flowable									P. 20
Semi-flowable									P. 20
Flowable									P. 20
Semi-flowable						●			P. 27
Semi-flowable						●			P. 27
Semi-flowable						●			P. 27
Semi-flowable						●			P. 27
Flowable							●		P. 22
Flowable									P. 24
Flowable	UL94 V-0		●						P. 24
Flowable	UL94 V-0		●						P. 24
Flowable	UL94 V-0		●						P. 24
Semi-flowable						●			P. 27
Semi-flowable						●			P. 27

## Product Overview: Encapsulants and Potting Materials

Type	Grade	Cure Chemistry	Cured Property	Feature
1 Part Cond. Cure	RTV160	Alkoxy	Rubber	UL certified flowable encapsulant.
	TSE398	Alkoxy	Rubber	Pourable coating / encapsulant.
	TN3705	Alkoxy	Rubber	Low volatile, low viscosity potting / coating material.
	XE11-A5133S	Alkoxy	Rubber	Low volatile, UL certified, thermally conductive coating & potting.
	RTV110 series	Acetoxy	Rubber	General purpose coating / encapsulant. FDA, USDA, and NSF compliant. Mil Spec.
	RTV116	Acetoxy	Rubber	Temperature-resistant flowable sealant. FDA, USDA, and NSF compliant. Mil Spec.
1 Part Heat Cure	TSE325	Heat	Rubber	Flowable coating / encapsulant.
	TSE3250	Heat	Rubber	Flowable coating / encapsulant.
	TSE325-B	Heat	Rubber	Flowable coating / encapsulant.
	TSE3051	Heat	Gel	Low viscosity potting gel.
	TSE3051-FR	Heat	Gel	UL certified variant of TSE3051.
2 Part Room Temp. Cure	TSE3051-L	Heat	Gel	Low penetration variant of TSE3051.
	RTV11	Condensation	Rubber	General purpose encapsulation and potting. FDA compliant.
	RTV31	Condensation	Rubber	High temperature resistant potting. Good release properties.
	RTV566	Condensation	Rubber	Low volatile, high-low temperature-resistance.
	RTV60	Condensation	Rubber	Extreme high temperature-resistant coating / potting. Release capability.
	TSE3663	Condensation	Rubber	Flowable encapsulant / potting material.
	TSE3661	Condensation	Rubber	Flowable encapsulant / potting material.
2 Part Heat Cure	TSE3664K	Condensation	Rubber	UL certified, flowable encapsulant / potting material.
	RTV615	Heat	Rubber	High strength potting material. Fast cure at elevated temperatures.
	TSE3032	Heat	Rubber	Transparent potting / encapsulant with excellent release properties.
	TSE3033	Heat	Rubber	Low viscosity, transparent potting material. Fast cure at elevated temperatures.
	TSE3331	Heat	Rubber	UL certified, thermally conductive, coating / encapsulant.
	TSE3331K <sup>1</sup>	Heat	Rubber	Low viscosity variant of TSE3331.
	TSE3331K EX <sup>1</sup>	Heat	Rubber	Low viscosity variant of TSE3331.
	TSE3431	Heat	Rubber	UL certified, thermally conductive potting material. Release capability.
	TSE3431-H	Heat	Rubber	UL certified, thermally conductive potting material. Release capability.
	XE14-B7892	Heat	Rubber	UL certified low-viscosity potting material. Low temperature cure. Release capability.
	YE5822	Heat	Rubber	Low viscosity potting material. Good release properties.
	FRV138	Heat	Rubber	Soft fluorosilicone encapsulant.
	TIA216G	Heat	Rubber	Thermally conductive, low temperature / fast cure soft pottant.
	TIA222G	Heat	Rubber	Thermally conductive, low temperature / fast cure soft pottant. UL certified.
	RTV6136-D1	Heat	Gel	Low viscosity potting gel with fast cure at low temperatures.
TSE3062	Heat	Gel	Fast cure at low temperatures.	
TSE3070	Heat	Gel	High-elongation gel with low temperature cure.	

<sup>1</sup> TSE3331K for Asia Pacific, TSE3331K EX for Europe and the Americas

Performance									Product Detail
Flowability	Flame Retardancy	Low Volatility	Thermally Conductive	High Temp. Resistance	Low Temp. Resistance	FDA Compliant	MIL-Spec		
Flowable	UL94 HB								P. 14
Flowable									P. 15
Flowable		●							P. 15
Flowable	UL94 V-1	●	●						P. 14
Flowable						●	MIL-A-46106B		P. 17
Flowable				●		●	MIL-A-46106B		P. 17
Flowable									P. 20
Flowable									P. 20
Flowable									P. 20
Flowable									P. 25
Flowable	UL94 V-1								P. 25
Flowable									P. 25
Flowable						●			P. 22
Flowable				●					P. 22
Flowable		●		●	●				P. 21
Flowable				●					P. 21
Flowable									P. 22
Flowable	UL94 HB								P. 22
Flowable	UL94 V-0								P. 22
Flowable						●			P. 23
Flowable									P. 23
Flowable									P. 24
Flowable	UL94 V-0		●						P. 24
Flowable	UL94 V-0		●						P. 24
Flowable	UL94 V-0		●						P. 24
Flowable	UL94 V-0		●						P. 24
Flowable	UL94 V-0		●						P. 24
Flowable	UL94 V-0								P. 24
Flowable									P. 24
Flowable		●	●						P. 23
Flowable	UL94 V-0	●	●						P. 23
Flowable									P. 26
Flowable									P. 26
Flowable									P. 26

## Selection Guide

### 1 Part Grades

BLACK=Rubber RED=Gels

Alkoxy

Acetoxy

Oxime

Heat

Viscosity Range	Performance					
	Thermally Conductive	Low Volatility	UL Certified	Temp. Resistant	FDA Compliant	General Purpose
Non-Flowable	TN3085 XE11-B5320	TN3005 TN3085 XE11-B5320	TSE3854DS TN3085 RTV133 RTV167			TSE385
				FRV1106 RTV106	RTV100 RTV106	RTV157 TSE370
			TSE382 TSE384-B	TSE3826		
						XE13-B3208
High Viscosity		TSE3976-B	TSE3853-W TSE3976-B	TSE3976-B		TSE3971
				RTV159		
	TSE3843-W		TSE3843-W	TSE3877-B		
Medium Viscosity	TSE3941M XE11-A5133S	TSE3944 XE11-A5133S TN3305	TSE3944 XE11-A5133S RTV160 TN3305			TSE398
			RTV110	RTV116	RTV110 RTV116	
						TSE387 TSE388
	TSE3280-G TSE3281-G		TSE322S TSE325	TSE326 TSE3261-G TSE326M		TSE3221S
Low Viscosity		ECC3050S ECS0600 ECS0601 ECS0609FR TN3705	ECS0601 ECS0609FR			ECC3010
			TSE389			
			TSE3051FR			TSE3051 TSE3051-L TSE325 TSE3250 TSE3251 TSE3251-C TSE325-B

## Cure System Performance Guide

Attribute	Alkoxy		Acetoxy	Oxime	Heat Cure
	Fast Cure	Slow Cure			
Cure Byproduct	Alcohol	Alcohol	Acetic Acid	Methylethyl Ketoxime	None
Cure Speed	Fast	Slow	Fast	Moderate	Very Fast
Corrosion on Copper	None	None	Yes	Yes	None
Corrosion on Metals	None	None	Yes	None	None
Odor	Low	Low	Strong	Low	None
Strength	Good	Good	Very Strong	Good	Good

## 2 Part Grades

BLACK=Rubber RED=Gels Heat Room Temperature

Viscosity Range	Performance					
	Thermally Conductive	Low Volatility	UL Certified	Temp. Resistant	FDA Compliant	General Purpose
Non-Flowable						TSE3360
High Viscosity				RTV577 RTV88		
Medium Viscosity	TSE3380					
		RTV566		RTV31 RTV566 RTV60	RTV11	
Low Viscosity	TSE3331 TSE3331K TSE3431 TSE3431-H TIA222G TIA216G	TIA222G TIA216G	TSE3331 TSE3331K TSE3431 TSE3431-H XE14-B7892 TIA222G		RTV615	RTV6136-D1 TSE3032 TSE3033 TSE3062 TSE3070 TSE3330 YE5822 TSE3663
			TSE3661 TSE3664K			

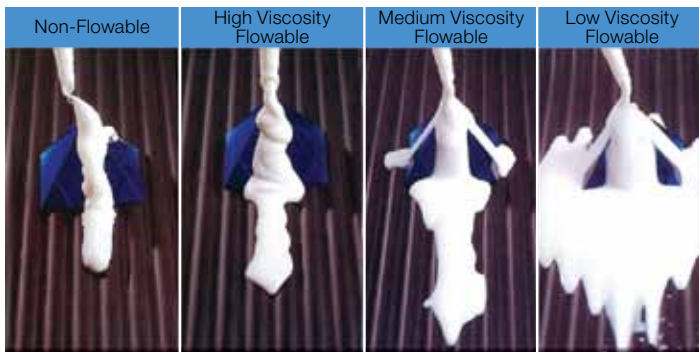

Viscosity and flowability of the silicone material are often key factors in the selection of a material for use in sealing, coating, and encapsulation / potting applications. A broad array of material performance and viscosity combinations are provided to help match the requirements of many applications.

## Application Geometry and Cure Chemistry Options

The shape and conditions of the part are important in selecting the suitable silicone grade for each application.

The following are some general guidelines:

### Shallow Cavity / Small Mass

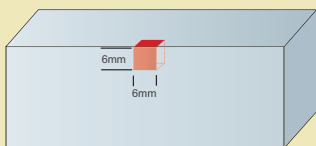

#### Selection Options:

- 1 Part Condensation Cure
- 1 Part Heat Cure
- 2 Part Room Temp. Cure
- 2 Part Heat Cure

### Complex Design - Exposed Surface

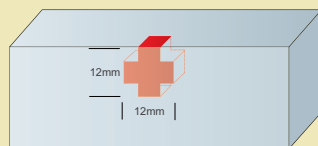

#### Selection Options:

- 1 Part Heat Cure
- 2 Part Room Temp. Cure
- 2 Part Heat Cure

### Deep Cavity / Large Mass

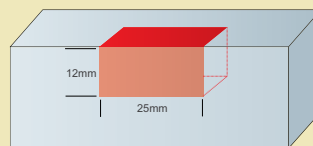

#### Selection Options:

- 1 Part Heat Cure
- 2 Part Room Temp. Cure
- 2 Part Heat Cure

### Enclosed System

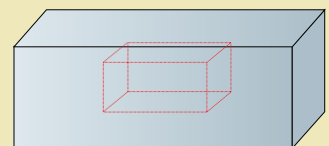

#### Selection Options:

- 1 Part Heat Cure
- 2 Part Heat Cure

## Product Details - 1 Part Condensation Cure Grades

Properties		RTV167	RTV133	TSE385	TSE3854DS	TN3005	TN3085	XE11-B5320
Cure Chemistry		Alkoxy	Alkoxy	Alkoxy	Alkoxy	Alkoxy	Alkoxy	Alkoxy
Flowability		Non-Flowable	Non-Flowable	Non-Flowable	Non-Flowable	Non-Flowable	Non-Flowable	Non-Flowable
Features and Benefits		High strength, paste adhesive with MILA-46106B and UL certified	UL certified paste adhesive.	Paste adhesive	Paste adhesive. UL certified	Fast tack, low volatile paste adhesive.	Fast tack, low volatile paste adhesive. UL certified	Fast tack, low volatile, thermally conductive paste adhesive. UL certified
Application	Adhesive / Sealant	●	●	●	●	●	●	●
	Coating							
	Encapsulant / Potting							
Viscosity (23°C)	Pa.s (P)	-	-	-	-	-	-	-
Application Rate	g/min	180	650	-	-	-	-	-
Tack Free Time	min	240	60	90	15	7	7	5
Specific Gravity (23°C)		1.12	1.23	1.10	1.33	1.04	1.63	2.59
Hardness		37	46	35	45	22	46	80
Tensile Strength	MPa (psi)	5.5 (800)	4.5 (650)	2.9 (420)	3.0 (435)	1.8 (260)	2.3 (335)	3.6 (520)
Elongation	%	600	250	390	300	330	150	40
Adhesive Strength	MPa (psi)	1.2 (175)	-	2.0 (290)	2.2 (320)	1.2 (175)	1.3 (190)	1.3 (190)
Thermal Conductivity	W/m-K	-	-	0.17	0.34	0.18	0.7	1.3
Volume Resistivity	MΩ·m	3.0x10 <sup>7</sup>	3.0x10 <sup>7</sup>	5.0x10 <sup>7</sup>	2.0x10 <sup>6</sup>	2.0x10 <sup>7</sup>	4.0x10 <sup>6</sup>	2.0x10 <sup>7</sup>
Dielectric Strength	kV/mm	20	20	22	25	26	23	17
Dielectric Constant (60Hz)		2.8	2.8 (100Hz)	3.0	3.1	2.7	4.0	2.6
Dissipation Factor (60Hz)		0.0026	0.001 (100Hz)	0.001	0.02	0.002	0.04	0.005
Low Molecular Siloxane (D4-D10) wt%		-	-	-	-	0.01	0.01	0.010
Flame Retardancy		UL94 HB	UL94 V-0		UL94 V-0		UL94 V-0	UL94 HB
Low Volatility						●	●	●
Temperature Resistance								
Thermally Conductive							●	●
FDA								
MIL-Spec <sup>3</sup>		MIL-A-46106B <sup>4</sup>						
Color	White			○	○	○	○	○
	Clear					○		
	Black		●			●		
	Gray	●					●	
Packaging	Tube	●		●	●		●	
	Cartridge	●	●	●	●		●	●
	Can							
	Pail							
See Page 15 for details						●		

<sup>1</sup>JIS K 6249 <sup>2</sup>ASTM D2196 <sup>3</sup>Testing is performed in accordance with current Momentive Performance Materials quality test methods, laboratory conditions, procedures, frequency and sampling. <sup>4</sup>MIL-A-46106B Group I Type I

### Cure Properties:

Condensation cure grades cure with exposure to atmospheric moisture. The cure process begins from the outer surface and proceeds inward. Therefore, deep section curing (in excess of 6mm) is not recommended. Typically, tack-free is achieved in 5-60 minutes at 25°C, 50%RH, depending on the grade.

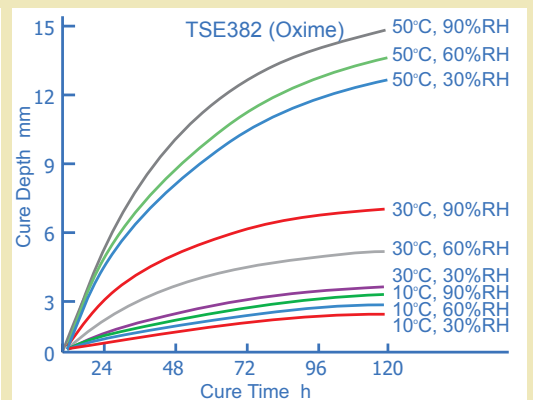
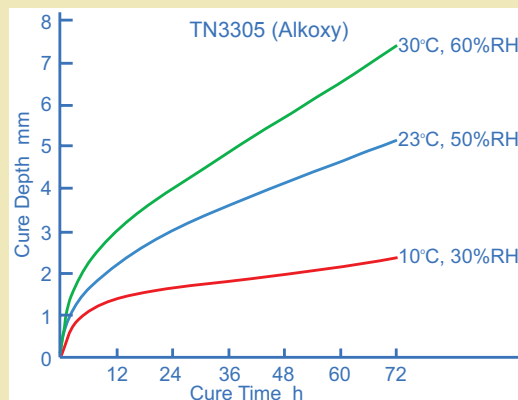

	TSE3944	TSE3853-W	TSE3971	TSE3976-B	XE11-A5133S	TSE3941M	TN3305	RTV160	ECS0609FR
	Alkoxy	Alkoxy	Alkoxy	Alkoxy	Alkoxy	Alkoxy	Alkoxy	Alkoxy	Alkoxy
	Semi-Flowable	Semi-Flowable	Flowable	Flowable	Flowable	Flowable	Flowable	Flowable	Flowable
	Flowable low volatile adhesive / sealant. UL certified	Flowable adhesive / sealant. UL certified	Flowable adhesive / sealant.	Flowable, high-temperature resistant low volatile adhesive / sealant. UL certified	Flowable, low volatile thermally conductive potting / coating material. UL certified	Fast tack, thermally conductive flowable adhesive / sealant.	Fast tack, low volatile, flowable adhesive / sealant.	Flowable adhesive. UL certified	High-purity electrode coating material with fast tack performance. UL certified
	●	●	●	●	●	●	●	●	●
	●		●	●	●	●	●	●	●
	-	400 (4000) <sup>1</sup>	100 (1000) <sup>1</sup>	100 (1000) <sup>1</sup>	60 (600) <sup>1</sup>	50 (500) <sup>1</sup>	47 (470) <sup>1</sup>	38 (380) <sup>2</sup>	18 (180) <sup>1</sup>
	-	-	-	-	-	-	-	-	-
	5	15	10	5	10	5	9	240	7
	1.31	1.31	1.04	1.08	1.64	1.64	1.04	1.04	1.22
	38	34	16	30	63	63	14	25	28
	1.5 (220)	2.3 (335)	1.5 (220)	1.7 (245)	3.9 (565)	3.2 (465)	1.5 (220)	1.9 (275)	2.4 (350)
	170	270	350	210	100	70	400	230	250
	1.0 (145)	1.3 (190)	1.1 (160)	1.3 (190)	1.3 (190)	1.4 (205)	1.0 (145)	-	1.2 (175)
	0.36	0.34	0.18	0.18	0.83	0.83	0.18	-	-
	1.0x10 <sup>7</sup>	2.0x10 <sup>6</sup>	2.0x10 <sup>7</sup>	1.0x10 <sup>7</sup>	4.0x10 <sup>6</sup>	4.0x10 <sup>6</sup>	2.0x10 <sup>7</sup>	4.0x10 <sup>6</sup>	1.0x10 <sup>5</sup>
	22	20	21	20	20	21	26	20	20
	3.8	3.1	2.9	3.5	4.0	4.0	2.7	2.8	3.1
	0.02	0.02	0.005	0.01	0.04	0.04	0.002	0.001	0.05
	0.028	-	-	0.025	0.025	-	0.01	-	-
	UL94 V-0	UL94 V-0		UL94 HB	UL94 V-1		UL94 HB	UL94 HB	UL94 V-0
	●			●	●		●		●
				●					
					●	●			
	○	○	○		○	○	○	○	
							○		
			●	●			●		
	●								●
	●	●	●	●	●	●			
	●	●	●	●	●	●		●	●
						●			
							●		

Typical property data values should not be used as specifications

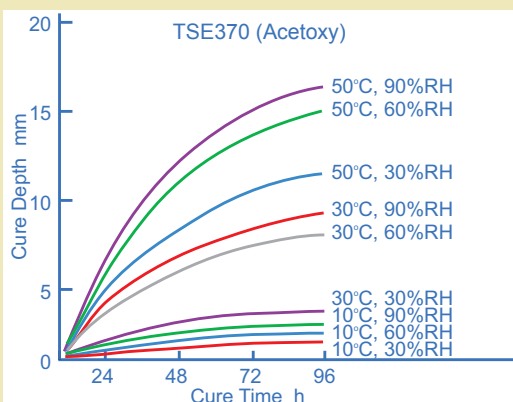

Adhesion is typically achieved after 5-15 hours. Full material properties including electronic performance, is achieved in up to 7 days.

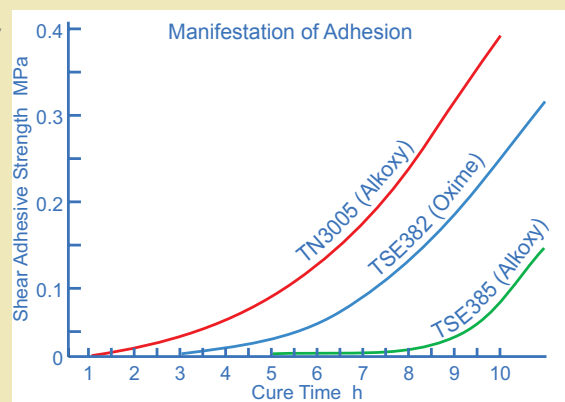

## Product Details - 1 Part Condensation Cure Grades

Properties		TSE398	ECS0600	TN3705	ECS0601	ECC3050S	ECC3010	TSE382	
Cure Chemistry		Alkoxy	Alkoxy	Alkoxy	Alkoxy	Alkoxy	Alkoxy	Oxime	
Flowability		Flowable	Flowable	Flowable	Flowable	Flowable	Flowable	Non-Flowable	
Features and Benefits		Flowable adhesive / sealant.	High-purity electrode coating material with fast tack performance. Repairable type	Low volatile potting and coating material	High-purity electrode coating material with fast tack performance	Fast cure conformal coating material. Low volatile. Solvent free	Fast cure conformal coating material. Solvent free	General purpose paste adhesive. UL certified	
Application	Adhesive / Sealant							●	
	Coating	●	●	●	●	●	●		
	Encapsulant / Potting	●		●					
Viscosity (23°C)	Pa.s (P)	17 (170) <sup>1</sup>	5.0 (50) <sup>1</sup>	1.5 (15) <sup>1</sup>	1.4 (14) <sup>1</sup>	0.55 (5.5) <sup>1</sup>	0.11 (1.1) <sup>1</sup>	-	
Application Rate	g/min	-	-	-	-	-	-	-	
Tack Free Time	min	10	7	7	7	5	3	10	
Specific Gravity (23°C)		1.04	1.03	1.01	1.01	0.98	0.99	1.04	
Hardness		14	20	13	25	22	35	28	
Tensile Strength	MPa (psi)	1.3 (190)	1.2 (175)	0.4 (60)	0.8 (115)	-	-	1.9 (275)	
Elongation	%	230	450	130	150	-	-	380	
Adhesive Strength	MPa (psi)	0.7 (100)	-	0.2 (30)	0.3 (45)	-	-	1.7 (245)	
Thermal Conductivity	W/m-K	0.18	-	0.18	-	-	-	0.18	
Volume Resistivity	MΩ-m	2.0x10 <sup>7</sup>	4.0x10 <sup>7</sup>	2.0x10 <sup>7</sup>	2.0x10 <sup>7</sup>	1.0x10 <sup>7</sup>	1.0x10 <sup>7</sup>	1.0x10 <sup>7</sup>	
Dielectric Strength	kV/mm	23	20	26	20	20	20	23	
Dielectric Constant (60Hz)		3.0	2.8	2.7	2.6	2.60	2.78	2.9	
Dissipation Factor (60Hz)		0.01	0.001	0.002	0.002	0.001	0.001	0.004	
Low Molecular Siloxane (D4-D10)	wt%	-	0.01	0.01	0.01	0.01	-	-	
Flame Retardancy					UL94 HB			UL94 HB	
Low Volatility			●	●	●	●			
Temperature Resistance									
Thermally Conductive									
FDA									
MIL-Spec									
Color	White	○	○	○	○			○	
	Clear			○		○	○	○	
	Black			●	●			●	
	Gray							●	
	Red								
Packaging	Tube	●							
	Cartridge	●	●		●				
	Can					●	●		
	Pail		●				●		
	See Page 15 for details			●				●	

<sup>1</sup>JIS K 6249

## Packaging Supplement

Grade	Tube			Cartridge				Can			Pail		
	W	C	B	W	C	B	G	W	C	B	W	C	B
TN3005	○	○		○	○	●					○	○	●
TN3305	○	○	●	○	○	●					○	○	●
TN3705	○	○	●	○	○	●		○	○	●	○	○	●
TSE382	○	○		○	○	●	●				○	○	
TSE387	○	○		○	○	●					○	○	
TSE389		○		○	○	●		○					

W: White, C: Clear, B: Black, G: Gray



	TSE3826	TSE384-B	TSE3843-W	TSE3877-B	TSE387	TSE388	TSE389	FRV1106
	Oxime	Oxime	Oxime	Oxime	Oxime	Oxime	Oxime	Acetoxy
	Non-Flowable	Non-Flowable	Semi-Flowable	Flowable	Flowable	Flowable	Flowable	Non-Flowable
	High temperature resistant paste adhesive	General purpose paste adhesive. UL certified	General purpose flowable adhesive / sealant. UL certified	General purpose flowable adhesive / sealant.	General purpose flowable adhesive / sealant.	General purpose flowable adhesive / sealant.	Flowable sealant / coating material. UL certified	Fluorosilicone with high temperature performance. Good fuel, oil, moisture, UV, ozone & chemical resistance
	●	●	●	●	●	●		●
				●	●	●	●	
	-	-	500 (5000) <sup>1</sup>	300 (3000) <sup>1</sup>	60 (600) <sup>1</sup>	10 (100) <sup>1</sup>	5.6 (56) <sup>1</sup>	-
	-	-	-	-	-	-	-	88
	10	60	60	20	90	60	30	20
	1.04	1.46	1.57	1.08	1.03	1.04	1.04	1.58
	29	50	60	25	25	16	30	42
	2.0 (290)	2.9 (421)	3.9 (565)	2.0 (290)	2.3 (335)	1.5 (220)	2.0 (290)	3.33 (485)
	400	270	130	440	350	330	200	230
	1.4 (205)	1.4 (203)	1.8 (260)	2.0 (290)	1.3 (190)	1.3 (190)	1.8 (260)	-
	0.18	0.59	0.67	0.18	0.18	0.18	0.18	-
	1.0x10 <sup>7</sup>	1.0x10 <sup>7</sup>	1.0x10 <sup>7</sup>	1.0x10 <sup>7</sup>	1.0x10 <sup>7</sup>	1.0x10 <sup>7</sup>	1.0x10 <sup>7</sup>	-
	23	22	21	20	20	20	20	13.7
	2.9	4.0	3.9	3.5	2.9	2.8	2.7	6.3 (1000Hz)
	0.004	0.016	0.02	0.01	0.004	0.008	0.009	-
	-	-	-	-	-	-	-	-
		UL94 V-0	UL94 V-1				UL94 HB	
	●			●				●
			●					
			○		○	○	○	
					○		○	
		●		●	●		●	
						●		
	●							●
	●	●	●	●		●		●
				●				
					●		●	

Typical property data values should not be used as specifications

## Product Details - 1 Part Condensation Cure Grades

Properties		RTV157	RTV159	RTV100 series	RTV106	TSE370	RTV116	RTV110 series
Cure Chemistry		Acetoxy	Acetoxy	Acetoxy	Acetoxy	Acetoxy	Acetoxy	Acetoxy
Flowability		Non-Flowable	Non-Flowable	Non-Flowable	Non-Flowable	Non-Flowable	Flowable	Flowable
Features and Benefits		High strength paste adhesive	High temperature, high strength, paste adhesive	Paste adhesive with FDA, USDA, NSF, and MIL-A-46106B	High temperature resistant paste adhesive. FDA, USDA, NSF, MIL-A-46106B	Fast tack paste adhesive	High temperature resistant, flowable adhesive. FDA, USDA, NSF, MIL-A-47040, MIL-A-46106B	Flowable adhesive with FDA, USDA, NSF, MIL-A-46106B
Application	Adhesive / Sealant	●	●	●	●	●	●	
	Coating							●
	Encapsulant / Potting						●	●
Viscosity (23°C)	Pa.s (P)	-	-	-	-	-	25 (250) <sup>1</sup>	20 (200) <sup>1</sup>
Application Rate	g/min	155	175	400	400	-	-	-
Tack Free Time	min	45	45	20	20	5	30	20
Specific Gravity (23°C)		1.09	1.09	1.05	1.07	1.04	1.09	1.05
Hardness		28	20	30	30	22	20	25
Tensile Strength	MPa (psi)	6.2 (900)	7.0 (1,025)	2.75 (400)	2.55 (370)	2.5 (365)	2.45 (355)	2.20 (320)
Elongation	%	825	350	450	400	530	350	325
Adhesive Strength	MPa (psi)	1.3 (183)	-	1.4 (200)	1.4 (200)	2.2 (320)	0.9 (125)	0.7 (100)
Thermal Conductivity	W/m-K	-	-	-	-	0.18	-	-
Volume Resistivity	MΩ-m	7.5x10 <sup>6</sup>	1.1x10 <sup>7</sup>	3.0x10 <sup>7</sup>	3.0x10 <sup>6</sup>	1.0x10 <sup>7</sup>	2.0x10 <sup>6</sup>	6.0x10 <sup>6</sup>
Dielectric Strength	kV/mm	20.7	19.7	20	20	22	16	16
Dielectric Constant (60Hz)		2.9	2.6	2.8	2.8	3.0	2.8	2.8
Dissipation Factor (60Hz)		0.0009	0.0007	0.001	0.001	0.003	0.001	0.001
Low Molecular Siloxane (D4-D10) wt%		-	-	-	-	-	-	-
Flame Retardancy								
Low Volatility								
Temperature Resistance			●		●		●	
Thermally Conductive								
FDA				●	●		●	●
MIL-Spec <sup>2</sup>				MIL-A-46106B <sup>3</sup>	MIL-A-46106B <sup>3</sup>		MIL-A-46106B <sup>3</sup>	MIL-A-46106B <sup>3</sup>
Color	White			RTV102		○		RTV112
	Clear			RTV108		○		RTV118
	Black			RTV103				
	Gray	●						
	Red		●		●		●	
	Aluminum			RTV109				
Packaging	Tube	●	●	●	●	●	●	●
	Cartridge	●	●	●	●			
	Can							
	Pail	●	●	●	●		●	●

<sup>1</sup>ASTM D2196 <sup>2</sup>Testing is performed in accordance with current Momentive Performance Materials quality test methods, laboratory conditions, procedures, frequency and sampling <sup>3</sup>MIL-A-46106B Group III Type I  
Typical property data values should not be used as specifications

## Product Details - 1 Part Heat Cure Grades

Properties		XE13-B3208	TSE3212	LA650S	TSE322	TSE322S	TSE3261-G
Flowability		Non-Flowable	Semi-Flowable	Non-Flowable	Semi-Flowable	Semi-Flowable	Flowable
Features and Benefits		Paste adhesive / sealant	Thixotropic adhesive / sealant	Non-flowable adhesive that cures to a tough silicone elastomer	Flowable adhesive / sealant	Flowable adhesive / sealant. UL certified	High temperature resistant flowable adhesive / sealant
Application	Adhesive / Sealant	●	●	●	●	●	●
	Coating						
	Encapsulant / Potting						
Viscosity (23°C)	Pa.s (P)	670 (6700) <sup>1</sup>	280 (2800) <sup>1</sup>	150 (1500) <sup>1</sup>	110 (1100) <sup>1</sup>	70 (700) <sup>1</sup>	50 (500) <sup>1</sup>
Cure Condition	°C/h	150/1	150/1	125/1.5	150/1	150/1	150/1
Specific Gravity (23°C)		1.08	1.26	1.10	1.27	1.26	1.48
Hardness		50	52	65	45	37	52
Tensile Strength	MPa (psi)	4.4 (640)	3.7 (535)	6.5 (950)	3.4 (495)	3.6 (520)	4.9 (710)
Elongation	%	430	240	120	230	230	160
Adhesive Strength	MPa (psi)	3.7 (535)	2.6 (375)	5.0 (730)	2.5 (365)	2.5 (365)	2.0 (290)
Thermal Conductivity	W/m·K	0.20	0.29	0.2	0.29	0.29	0.41
Volume Resistivity	MΩ·m	1.0x10 <sup>7</sup>	2.0x10 <sup>7</sup>	6.0x10 <sup>7</sup>	2.0x10 <sup>7</sup>	1.0x10 <sup>7</sup>	2.0x10 <sup>7</sup>
Dielectric Strength	kV/mm	23	20	22	20	25	22
Dielectric Constant (60Hz)		3.1	3.2	2.9	3.1	3.1	3.9
Dissipation Factor (60Hz)		0.001	0.001	0.01	0.006	0.006	0.005
Flame Retardancy						UL94 HB	
Temperature Resistance							●
Thermally Conductive							
Color	White		●				
	Clear	●					
	Black			●	●		
	Gray						●
	Blue				●	●	
Packaging	Tube		●		●		
	Cartridge	●	●	●	●	●	
	Can		●		●	●	
	Pail	●	●		●	●	●

<sup>1</sup>JIS K 6249

Typical property data values should not be used as specifications

### Cure Properties:

The cure performance of 1 Part Heat Cure grades is demonstrated by the relationship between temperature and hardness, and temperature and adhesive strength of TSE322 when placed in an oven at temperatures ranging from 80°C to 150°C.

### Hardness & Cure Time - TSE322

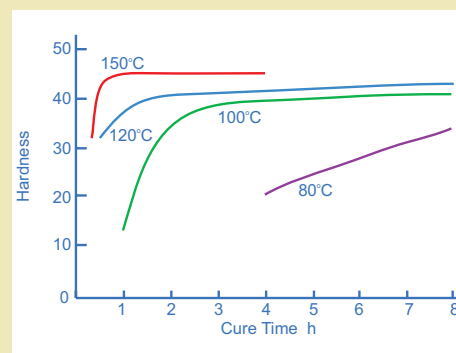

### Adhesion & Cure Time - TSE322

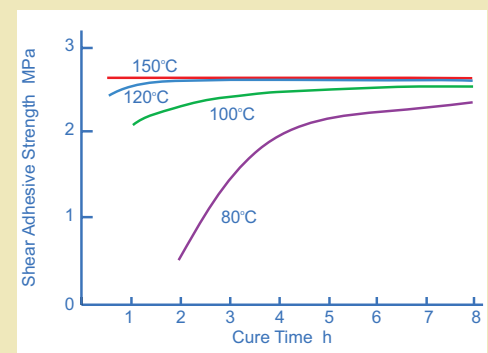

## Product Details - 1 Part Heat Cure Grades

Properties		TSE3280-G	TSE3281-G	TSE3221S	TSE326
Flowability		Flowable	Flowable	Flowable	Flowable
Features and Benefits		Thermally conductive flowable adhesive	Thermally conductive flowable adhesive	Flowable adhesive / sealant, coating material	High temperature resistant flowable adhesive. UL certified
Application	Adhesive / Sealant	●	●	●	●
	Coating			●	
	Encapsulant / Potting				
Viscosity (23°C)	Pa.s (P)	60 (600) <sup>1</sup>	60 (600) <sup>1</sup>	58 (580) <sup>1</sup>	28 (280) <sup>1</sup>
Cure Condition	°C/h	150/1	150/1	150/1	150/1
Specific Gravity (23°C)		2.10	2.70	1.03	1.45
Hardness		62	84	28	43
Tensile Strength	MPa (psi)	3.2 (465)	4.5 (655)	2.8 (405)	3.4 (495)
Elongation	%	110	50	370	170
Adhesive Strength	MPa (psi)	2.0 (290)	2.5 (365)	2.5 (365)	2.0 (290)
Thermal Conductivity	W/m-K	0.88	1.68	0.18	0.41
Volume Resistivity	MΩ-m	2.5x10 <sup>6</sup>	4.8x10 <sup>6</sup>	6.0x10 <sup>7</sup>	2.0x10 <sup>7</sup>
Dielectric Strength	kV/mm	21	15	23	22
Dielectric Constant (60Hz)		4.3	5.2	2.8	3.3
Dissipation Factor (60Hz)		0.002	0.002	0.001	0.02
Flame Retardancy					UL94 HB
Temperature Resistance					●
Thermally Conductive		●	●		
Color	White				
	Clear			○	
	Black				
	Gray	●	●		
	Red				●
Packaging	Tube	●		●	●
	Cartridge	●			●
	Can	●	●	●	●
	Pail	●			●

<sup>1</sup>JIS K 6249    <sup>2</sup>ASTM D2196    <sup>3</sup>TSE326M EX in Europe and the Americas.

### Storage Stability:

Storage under low temperature conditions is important particularly for 1-part heat cure grades to prevent viscosity increase.

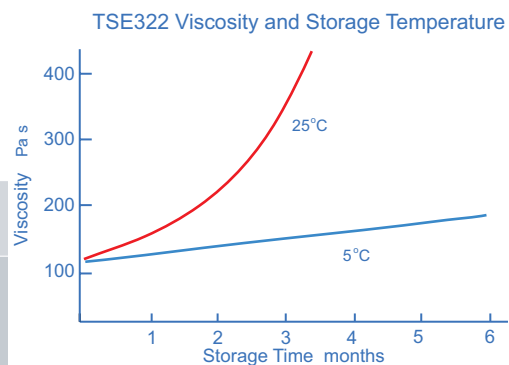

	TSE326M <sup>3</sup>	TSE3251	TSE3251-C	TSE325	TSE325-B	TSE3250	ECC4865
	Flowable	Semi-Flowable	Semi-Flowable	Flowable	Flowable	Flowable	Flowable
	High temperature resistant flowable adhesive	Flowable coating material	Flowable coating material	Flowable potting / coating material	Flowable potting / coating material	Flowable potting / coating material	Low viscosity conformal coating with UV tracer, fast thermal cure & long-term viscosity stability
	●						
		●	●	●	●	●	●
				●	●	●	
	16 (160) <sup>1</sup>	8.5 (85) <sup>1</sup>	7.0 (70) <sup>1</sup>	4.0 (40) <sup>1</sup>	3.5 (35) <sup>1</sup>	1.3 (13) <sup>1</sup>	0.25 (2.5) <sup>2</sup>
	200/0.5	150/1	150/1	150/1	150/1	150/1	-
	1.46	1.02	1.02	1.02	1.02	0.97	1.19
	38	16	16	12	20	9	35
	2.9 (420)	0.7 (100)	0.7 (100)	0.7 (100)	0.9 (130)	-	-
	180	200	200	200	200	-	-
	1.5 (220)	0.4 (60)	0.4 (60)	0.4 (60)	0.4 (60)	0.1 (15)	-
	0.41	0.18	0.18	0.18	0.18	0.17	-
	2.0x10 <sup>7</sup>	2.0x10 <sup>7</sup>	2.0x10 <sup>7</sup>	2.0x10 <sup>7</sup>	2.0x10 <sup>7</sup>	2.0x10 <sup>7</sup>	-
	22	20	20	21	21	21	20
	3.3	2.8	2.8	2.9	2.9	2.8	2.4
	0.02	0.002	0.001	0.001	0.001	0.001	0.01
	●						
		○		○			
			○			○	○
					●		
	●						
	●	●	●	●	●	●	
				●			●

Typical property data values should not be used as specifications

## Product Details - 2 Part Room Temperature Cure Grades

Properties		RTV577		RTV88		RTV60		RTV566	
Components		RTV577 <sup>3</sup>	DBT	RTV88 <sup>3</sup>	DBT	RTV60 <sup>3</sup>	DBT	RTV566(A) <sup>3</sup>	RTV566(B) <sup>3</sup>
Flowability		Non-Flowable		Semi-Flowable		Flowable		Flowable	
Features and Benefits		Low temperature resistant paste sealant with good release capabilities		High temperature resistant, semi-flowable sealant. Good release capabilities		High temperature resistant flowable sealant with good release capabilities		Low volatile, low out gassing sealant with Low and High temperature performance capability	
Application	Adhesive / Sealant	●		●					
	Coating								
	Encapsulant / Potting					●		●	
Mixing Ratio ((A):(B) by weight)		100:0.5		100:0.5		100:0.5		100:0.1	
Color (mixed)		White		Red		Red		Red	
Viscosity (mixed) (23°C)		Pa.s (P)	700 (7000) <sup>2</sup>	880 (8800) <sup>2</sup>	47 (470) <sup>2</sup>	43 (430) <sup>2</sup>			
Pot Life (23°C)		h	2	0.75	2	1.5			
Cure Condition		°C/h	25/24	25/24	25/24	25/24			
Specific Gravity (23°C)			1.35	1.47	1.48	1.49			
Hardness			48	58	57	61			
Tensile Strength		MPa (psi)	3.0 (440)	5.8 (840)	6.9 (995)	5.5 (795)			
Elongation		%	150	120	120	120			
Adhesive Strength		MPa (psi)	-	-	-	3.2 (465)			
Thermal Conductivity		W/m-K	0.31	0.31	0.31	0.31			
Volume Resistivity		MΩ-m	5.6x10 <sup>6</sup>	2.8x10 <sup>6</sup>	4.4x10 <sup>6</sup>	2.0x10 <sup>6</sup>			
Dielectric Strength		kV/mm	18.5	17.4	17.7	21.2			
Dielectric Constant (60Hz)			3.98 (1kHz)	4.3 (1kHz)	4.0 (1kHz)	3.9 (1kHz)			
Dissipation Factor (60Hz)			0.02 (1kHz)	0.03 (1kHz)	0.02 (1kHz)	0.02 (1kHz)			
Flame Retardancy									
Low Volatility							●		
Temperature Resistance			●	●	●	●			
FDA									
Packaging	Bottle								
	Can								
	Pail								
	Kit		●	●	●	●			

<sup>1</sup>JIS K 6249    <sup>2</sup>ASTM D2196    <sup>3</sup>Sub-Zero long-term storage required.

### Cure Speed:

The cure speed of 2 Part Condensation Cure grades can be changed by adjusting the amount of the catalyst component. However, the post-cure properties of the material may vary from those achieved under standard mixing ratios, and therefore adequate testing and confirmation prior to use in an application is required.

### TSE3663 - Mixing Ratios & Viscosity (23°C)

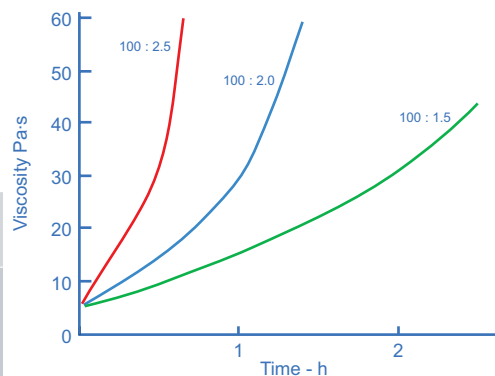

	RTV31		RTV11		TSE3663		TSE3661		TSE3664K	
	RTV31 <sup>3</sup>	DBT	RTV11 <sup>3</sup>	DBT	TSE3663(A)	TSE3663(B)	TSE3661(A)	TSE3661(C)	TSE3664(A)	TSE3664(B)
	Flowable		Flowable		Flowable		Flowable		Flowable	
	High temperature resistant flowable sealant with good release capabilities		Sealant with good release properties. FDA compliance		Flowable encapsulant / adhesive		Flowable encapsulant / adhesive with fast tack free times. UL certified		Flowable encapsulant / adhesive with fast tack free times. UL certified	
			●							
	●		●		●		●		●	
	100:0.5		100:0.5		100:2		100:3		100:7.5	
	Red		White		Off-White		Blue Green		Gray	
	25 (250) <sup>2</sup>		11 (110) <sup>2</sup>		4.0 (40) <sup>1</sup>		3.5 (35) <sup>1</sup>		3.0 (30) <sup>1</sup>	
	2		1.5		0.5		0.1		0.1	
	25/24		25/24		23/72		23/72		23/72	
	1.42		1.19		1.19		1.20		1.41	
	54		41		42		30		60	
	5.9 (870)		2.1 (300)		1.4 (205)		1.1 (160)		3.0 (435)	
	170		160		110		120		70	
	-		-		0.9 (130)		0.8 (115)		1.0 (145)	
	0.31		0.29		0.27		-		0.42	
	1.6x10 <sup>6</sup>		1.1x10 <sup>7</sup>		1.0x10 <sup>7</sup>		1.0x10 <sup>7</sup>		5.0x10 <sup>7</sup>	
	17		20.3		20		20		26	
	4.4 (1kHz)		3.3 (1kHz)		3.1		3.2		3.1	
	0.03 (1kHz)		0.006 (1kHz)		0.025		0.02		0.01	
							UL94 HB		UL94 V-0	
	●									
			●							
					●	●	●	●	●	●
					●		●		●	
					●		●		●	
	●		●							

Typical property data values should not be used as specifications

## Product Details - 2 Part Heat Cure Grades

Properties		TSE3360		TSE3380		TIA222G		FRV138		TIA216G		RTV615		TSE3032	
Components		TSE3360(A)	TSE3360(B)	TSE3380(A)	TSE3380(B)	TIA222G(A)	TIA222G(B)	FRV138(A)	FRV138(B)	TIA216G(A)	TIA216G(B)	RTV615(A)	RTV615(B)	TSE3032(A)	TSE3032(B)
Flowability		Non-Flowable		Flowable		Flowable		Flowable		Flowable		Flowable		Flowable	
Features and Benefits		General purpose paste adhesive with extended pot life		Thermally conductive adhesive		Thermally conductive, low temperature/fast cure, UL certified		Fluorosilicone encapsulant		Thermally conductive, low temperature/fast cure		Low viscosity encapsulant / potting material with capability to cure at RT. FDA recognition		Transparent encapsulant / potting material with good release properties	
Application	Adhesive / Sealant	●		●											
	Coating														
	Encapsulant / Potting					●		●		●		●		●	
Mixing Ratio ((A):(B) by weight)		100:100		100:100		100:100		100:100		100:100		100:10		100:10	
Color (mixed)		White		Gray		Gray		Translucent		Gray		Transparent		Transparent	
Viscosity (mixed) (23°C)		Pa.s (P)	640 (6400) <sup>1</sup>	40 (400) <sup>1</sup>	20 (200) <sup>1</sup>	13 (130)	8 (80) <sup>1</sup>	4.0 (40) <sup>2</sup>	4.0 (40) <sup>1</sup>						
Pot Life (23°C)		h	24	8	4	8	0.5	4	4						
Cure Condition		°C/h	150/1	150/0.5	70/0.5	150/1	70/0.5	150/0.25	100/1						
Specific Gravity (23°C)			1.12	2.70	2.81	1.3	2.69	1.02	1.02						
Hardness			42	70	45 (type E)	55 (shore 00)	45 (type E)	44	35						
Tensile Strength		MPa (psi)	5.4 (785)	2.5 (365)	0.3 (44)	0.3 (44)	0.2 (29)	6.3 (920)	4.5 (655)						
Elongation		%	380	100	40	73	40	120	210						
Adhesive Strength		MPa (psi)	3.1 (450)	1.5 (220)	-	-	-	-	-						
Thermal Conductivity		W/m·K	0.23	1.68	2.1	-	1.6	0.19	0.17						
Volume Resistivity		MΩ·m	1.0x10 <sup>7</sup>	2.1x10 <sup>6</sup>	4.8x10 <sup>6</sup>	1.6x10 <sup>2</sup>	4.8x10 <sup>6</sup>	1.8x10 <sup>7</sup>	2.0x10 <sup>7</sup>						
Dielectric Strength		kV/mm	21	15	20	-	18	19.7	21						
Dielectric Constant (60Hz)			3.0	5.7	5.3	7.2	5.0	2.7 (1kHz)	2.8						
Dissipation Factor (60Hz)			0.001	0.002	0.002	-	0.002	0.0006 (1kHz)	0.001						
Low Molecular Siloxane (D4-D10) wt%					0.02		0.02								
Flame Retardancy					UL94 V-0										
Thermally Conductive				●	●		●								
FDA									●						
Packaging	Bottle														●
	Can					●	●			●	●			●	
	Pail	●	●	●	●	●	●			●	●			●	
	Kit							●				●			

<sup>1</sup>JIS K 6249 <sup>2</sup>ASTM D2196 <sup>3</sup>TSE3331K unavailable in Europe and the Americas <sup>4</sup>TSE3331K EX unavailable in Asia

### Pot Life:

The pot life of a 2 Part Heat Cure grade is affected by changes in viscosity that occur after the components have been mixed.

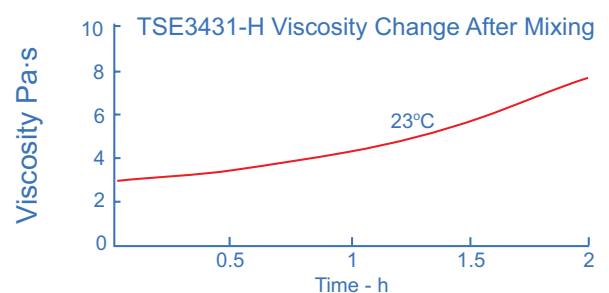
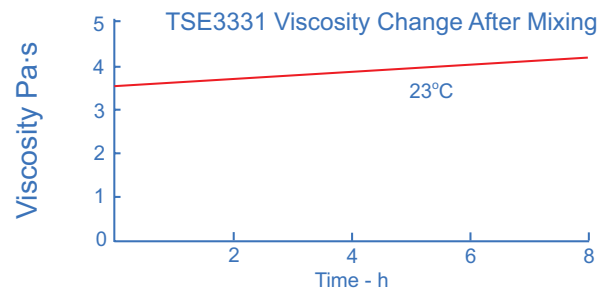



TSE3331		TSE3431		TSE3331K EX <sup>4</sup>		TSE3331K <sup>3</sup>		TSE3431-H		XE14-B7892		YE5822		TSE3033	
TSE3331(A)	TSE3331(B)	TSE3431(A)	TSE3431(B)	TSE3331KEX(A)	TSE3331KEX(B)	TSE3331K(A)	TSE3331K(B)	TSE3431-H(A)	TSE3431-H(B)	XE14-B7892(A)	XE14-B7892(B)	YE5822(A)	YE5822(B)	TSE3033(A)	TSE3033(B)
Flowable		Flowable		Flowable		Flowable		Flowable		Flowable		Flowable		Flowable	
Thermally conductive encapsulant / potting material. UL certified		Encapsulant / potting material with UL certified, thermal conductivity, and good release properties		Thermally conductive encapsulant / potting material. UL certified		Thermally conductive encapsulant / potting material. UL certified		Encapsulant / potting material with UL certified, thermal conductivity, and good release properties		Encapsulant / potting material with UL certified, low temperature cure, and good release properties		Low viscosity transparent encapsulant / potting material. Good release properties		Low viscosity transparent encapsulant / potting material	
●				●		●								●	
●		●		●		●		●		●		●		●	
100:100		100:10		100:100		100:100		100:10		100:100		100:10		100:100	
Gray		Black		Dark Gray		Dark Gray		Black		Black		Transparent		Transparent	
3.5 (35) <sup>1</sup>		3.3 (33) <sup>1</sup>		3.0 (30) <sup>1</sup>		2.6 (26) <sup>1</sup>		2.6 (26) <sup>1</sup>		1.3 (13) <sup>1</sup>		1.0 (10) <sup>1</sup>		0.9 (9) <sup>1</sup>	
8		1.5		8		8		1.5		2		4		6	
120/1		100/1		120/1		120/1		100/1		60/1		100/1		150/0.5	
1.51		1.50		1.43		1.43		1.52		1.39		0.97		1.01	
60		70		50		45		70		60		27		30	
2.9 (420)		4.9 (710)		3.0 (440)		3.1 (450)		4.1 (595)		3.5 (510)		0.4 (58)		1.0 (145)	
70		70		100		120		60		100		130		130	
1.3 (190)		-		1.6 (230)		1.6 (230)		-		-		-		0.3 (44)	
0.63		0.63		0.53		0.53		0.63		0.44		0.17		0.17	
2.0x10 <sup>6</sup>		5.0x10 <sup>7</sup>		6.0x10 <sup>6</sup>		6.0x10 <sup>6</sup>		5.0x10 <sup>6</sup>		2.0x10 <sup>7</sup>		2.0x10 <sup>7</sup>		2.0x10 <sup>7</sup>	
26		26		22		22		27		27		21		21	
3.4		3.4		3.1		3.1		3.5		3.1		2.8		2.8	
0.017		0.014		0.015		0.015		0.014		0.01		0.001		0.001	
UL94 V-0		UL94 V-0		UL94 V-0		UL94 V-0		UL94 V-0		UL94 V-0					
●		●		●		●		●							
												●			
●		●		●		●		●		●		●		●	
●		●						●		●				●	

**Cure Properties:**

The cure performance of 2 Part Heat Cure grades is demonstrated by the relationship between temperature and hardness of TSE3380 when placed in an oven at temperatures ranging from 100°C to 150°C.

**Hardness & Cure Time - TSE3380**

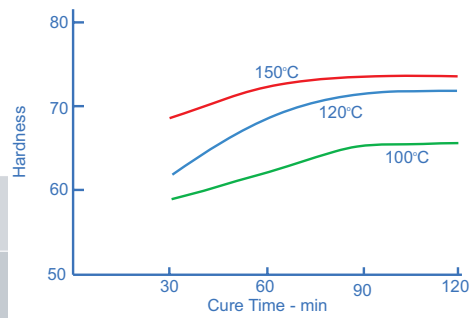

## Product Details - 1 Part Gels

Properties		TSE3051	TSE3051-FR	TSE3051-L
Flowability		Flowable	Flowable	Flowable
Features and Benefits		Low viscosity	Low viscosity, UL certified	Low viscosity, low penetration
Viscosity (23°C)	Pa.s (P)	0.7 (7) <sup>1</sup>	0.7 (7) <sup>1</sup>	0.7 (7) <sup>1</sup>
Cure Condition	°C/h	125/2	150/1	125/2
Specific Gravity (23°C)		0.97	0.97	0.97
Penetration		85	85	65
Thermal Conductivity	W/m.K	0.17	0.17	0.17
Volume Resistivity	MΩ.m	1.0x10 <sup>7</sup>	5.0x10 <sup>7</sup>	1.0x10 <sup>7</sup>
Dielectric Strength		18	18	18
Dielectric Constant (60Hz)		2.8	2.8	2.8
Dissipation Factor (60Hz)		0.001	0.001	0.001
Flame Retardancy			UL94 V-1	
Color	White	●		
	Transparent	●	●	●
Pkg	1kg can	See below matrix	●	●
	15kg can		●	●

<sup>1</sup>JIS K 6249 Typical property data values should not be used as specifications

TSE3051	W	C
1kg bottle	●	●
4kg can		●
15kg can		●
20kg pail		●

W: White, C: Clear



## Product Details - 2 Part Gels

Properties		TSE3062		TSE3070		RTV6136-D1	
		TSE3062(A)	TSE3062(B)	TSE3070(A)	TSE3070(B)	RTV6136(A)	RTV6136(B)
Components		TSE3062(A)	TSE3062(B)	TSE3070(A)	TSE3070(B)	RTV6136(A)	RTV6136(B)
Flowability		Flowable		Flowable		Flowable	
Features and Benefits		Low temperature cure		High elongation gel		Fast cure, low viscosity	
Mixing Ratio ((A):(B) by weight)		100:100		100:100		100:100	
Color (mixed)		Transparent		Transparent		Transparent	
Viscosity (mixed) (23°C)	Pa.s (P)	1.0 (10) <sup>1</sup>		0.8 (8) <sup>1</sup>		0.75 (7.5) <sup>2</sup>	
Pot Life (23°C)	h	1		4		0.5	
Cure Condition	°C/h	70/0.5		70/0.5		100/0.3	
Specific Gravity (23°C)		0.97		0.97		0.98	
Penetration		55		65		60	
Thermal Conductivity	W/m.K	0.17		0.17		0.19	
Volume Resistivity	MΩ-m	1.0x10 <sup>7</sup>		1.0x10 <sup>7</sup>		1.0x10 <sup>7</sup>	
Dielectric Strength	kV/mm	18		18		20.5	
Dielectric Constant (60Hz)		2.7		2.7		2.8 (1kHz)	
Dissipation Factor (60Hz)		0.001		0.001		0.001 (1kHz)	
Packaging	Can	●	●	●	●		
	Pail			●	●		●

<sup>1</sup>JIS K 6249 <sup>2</sup>ASTM D2196  
 Typical property data values should not be used as specifications

## Product Details - 1 Part JCR Grades

Properties		TSJ3187	TSJ3155	TSJ3195-W	TSJ3185
Flowability		Semi-Flowable	Semi-Flowable	Semi-Flowable	Semi-Flowable
Features and Benefits		Thixotropic JCR gel. Provides stress and vibration relief performance	Thixotropic JCR rubber. Low post-cure hardness contributes to stress relief of critical components	Low viscosity JCR gel. Provides stress and vibration relief performance	Thixotropic JCR gel. Provides stress and vibration relief performance
Property		Gel	Rubber	Gel	Gel
Viscosity (23°C)	Pa.s (P)	12 (120) <sup>1</sup>	6 (60) <sup>1</sup>	4 (40) <sup>1</sup>	3 (30) <sup>1</sup>
Color		Translucent	White	White	Translucent
Cure Condition	°C/h	150/4	150/4	150/4	150/4
Specific Gravity (23°C)		1.00	1.02	1.00	1.01
Hardness		-	11	-	-
Penetration		40	-	80	80
Thermal Conductivity	W/m-K	0.18	0.18	0.18	0.18
Volume Resistivity	MΩ-m	5.0x10 <sup>7</sup>	1.0x10 <sup>7</sup>	1.0x10 <sup>7</sup>	1.0x10 <sup>7</sup>
Dielectric Strength	kV/mm	25	20	15	15
Dielectric Constant (60Hz)		2.7	2.8	2.8	2.7
Dissipation Factor (60Hz)		0.0006	0.0004	0.0004	0.001
Na <sup>+</sup> K <sup>+</sup>	ppm	<2	<2	<2	<2
Pkg: 500g bottle		●	●	●	●

<sup>1</sup>JIS K 6249 Typical property data values should not be used as specifications

## Product Details - 2 Part JCR Grades

Properties		XE14-B5778	TSJ3175
Components		XE14-B5778(A) XE14-B5778(B)	TSJ3175(A) TSJ3175(B)
Flowability		Semi-Flowable	Semi-Flowable
Features and Benefits		Flow-controllable JCR rubber.	Thixotropic JCR gel. Soft gel property contributes to stress and vibration relief
Property		Rubber	Gel
Mixing Ratio ((A):(B) by weight)		100:100	100:100
Color (mixed)		Translucent	Black
Viscosity (mixed) (23°C)	Pa.s (P)	14 (140) <sup>1</sup>	17 (170) <sup>1</sup>
Pot Life (23°C)	h	8	12
Cure Condition	°C/h	80/2	125/2
Specific Gravity (23°C)		1.02	1.01
Hardness		16	-
Penetration		-	70
Thermal Conductivity	W/m-K	0.17	0.18
Volume Resistivity	MΩ-m	2.0x10 <sup>5</sup>	1.0x10 <sup>7</sup>
Dielectric Strength	kV/mm	24	15
Dielectric Constant (60Hz)		2.7	2.7
Dissipation Factor (60Hz)		0.001	0.001
Na <sup>+</sup> K <sup>+</sup>	ppm	<2	<2
Pkg: 500g bottle		● ●	● ●

<sup>1</sup>JIS K 6249 Typical property data values should not be used as specifications

## Product Details - Grease

Properties	TSK5303	TSK5370	TSK550	TSK551	YG6111	YG6240	YG6260	TIG1000
Features and Benefits	Thermally conductive compound for medium heat dissipation. Heat resistance	Compound for electrical insulation & sealing with swell resistant performance	Compound for electrical contact insulation protection against moisture & contaminants	Compound for electrical contact insulation protection against moisture & contaminants	Thermally conductive compound for medium heat dissipation. Low oil separation	Thermally conductive compound for medium heat dissipation. Low oil separation	Thermally conductive compound for medium heat dissipation. Low oil separation	Thermally conductive compound for medium to high heat dissipation applications
Color	White	White	White	Green	White	White	White	White
Specific Gravity	2.34	-	1.03	1.03	2.45	2.45	2.30	2.50
Penetration	330	270	220	220	310	290	300	340
Bleed (150°C, 24h) %	2.8	1.5	1.5	1.0	0.4	0.0	0.5	0.1
Evaporation (150°C, 24h) %	0.2	0.2	0.2	0.3	0.1	0.4	0.1	0.1
Thermal Conductivity W/m·K	0.84	-	-	-	0.84	0.84	0.84	1.00
Volume Resistivity MΩ·m	-	1.0x10 <sup>5</sup>	2.0x10 <sup>7</sup>	2.0x10 <sup>7</sup>	2.0x10 <sup>6</sup>	2.0x10 <sup>6</sup>	2.0x10 <sup>7</sup>	3.0x10 <sup>6</sup>
Dielectric Constant (60Hz)	5.0	2.5	2.8	2.8	5.0	5.0	5.0	5.0
Dissipation Factor (60Hz)	0.005	0.0001	0.0002	0.0002	0.006	0.006	0.005	0.006
Low Molecular Siloxane (D4-D10) wt%	0.0015	0.01	-	-	0.01	0.003	0.003	0.003
Arc Resistance <sup>1</sup> s	-	-	120<	120<	-	-	-	-
Low Volatility	●	●			●	●	●	●
Temperature Resistance	●							
Thermally Conductive	●				●	●	●	●
Low Bleed						●		
Packaging	Tube		●	●	●	●	●	
	Can	●		●	●	●	●	●
	Pail			●		●	●	

Typical property data values should not be used as specifications

# UL Certifications

source: Underwriters Laboratories Inc.

Type	Grade	Color	Thickness mm	RTI		Flame Class	HWI (PLC)	HAI (PLC)	HVTR (PLC)	D495 (PLC)	CTI (PLC)	File No.
				Elec.	Mech.							
1 Part Condensation Cure	ECS0601	Black Clear White	1.5	105	105	HB	-	-				E56745
	ECS0609FR	Gray	0.2	105	105	V-0	-	-				E56745
		Gray	3.0	105	105	V-0	-	-				
	TN3085	Gray	1.0	105	105	V-1	0	0	0	4	0	E56745
		Gray	3.0	105	105	V-0	0	0				
		White	1.0	105	105	V-1	2	0	0	3	0	
		White	3.0	105	105	V-0	1	0				
	RTV133	Black	0.71	105	105	V-1	3	0	0	3	0	E36952
		Black	1.6	105	105	V-1	2	0				
		Black	3.4	105	105	V-0	1	0				
	RTV160	White	0.75	105	105	HB	4	0	1	5	0	E36952
		White	1.5	105	105	HB	3	0				
		White	2.5	105	105	HB	3	0				
		White	3.0	105	105	HB	-	-				
	RTV167	Gray	0.83	105	105	HB	3	0	0	5	0	E36952
		Gray	1.5	105	105	HB	2	0				
		Gray	2.6	105	105	HB	2	0				
	TSE382	Clear White	0.75	105	105	HB	4	0	0	4	0	E56745
		Clear White	1.5	105	105	HB	3	0				
		Clear White	1.9	150	140	HB	3	0				
		Clear White	3.0	150	140	HB	3	0				
	TSE3826	Red	2.0	200	200	-	-	-				E56745
		Red	3.0	200	200	-	-	-				
	TSE3843-W	White	1.1	105	105	V-1	-	-	0	1	1	E56745
		White	1.5	105	105	V-1	0	0				
		White	1.9	150	140	V-1	-	-				
		White	2.5	150	140	V-1	-	-				
		White	3.0	150	140	V-1	-	-				
	TSE384-B	Black	1.2	105	105	V-0	0	0	0	3	1	E56745
		Black	1.9	150	140	V-0	-	-				
		Black	3.0	150	140	V-0	-	-				
	TSE3853-W	White	1.5	105	105	V-0	0	3	0	3	0	E56745
White		3.0	105	105	V-0	0	3					
TSE3854DS	Gray	0.75	105	105	V-0	0	0	0	3	0	E56745	
	Gray	1.5	105	105	V-0	0	0					
	Gray	3.0	105	105	V-0	0	0					
	White	1.5	105	105	V-0	0	3					
	White	3.0	105	105	V-0	0	3					
TSE389	Clear White Black	1.5	105	105	HB	-	-				E56745	
	Clear White Black	3.0	105	105	HB	-	-					
TSE3944	Gray	0.75	105	105	V-0	-	-	0	3	0	E56745	
	White	0.75	105	105	V-1	-	-					
	Gray White	1.5	105	105	V-0	0	0					
	Gray White	3.0	105	105	V-0	0	0					
TN3305	Clear White Black	1.5	105	105	HB	-	-				E56745	
	Clear White Black	3.0	105	105	HB	-	-					

RTI: Relative Temperature Index    PLC: Performance Level Category    HWI: Hot Wire Ignition    HAI: High-Current Arc Ignition  
 HVTR: High-Voltage Arc Tracking Rate    D495: D495 High-Voltage Dry Arc Resistance    CTI: Comparative Tracking Index

Type	Grade	Color	Thickness mm	RTI		Flame Class	HWI (PLC)	HAI (PLC)	HVTR (PLC)	D495 (PLC)	CTI (PLC)	File No.
				Elec.	Mech.							
1 P Cond Cure	TSE3976-B	Black	0.64	105	105	HB	-	-				E56745
		Black	1.5	105	105	HB	-	-				
		Black	3.0	105	105	HB	-	-				
	XE11-A5133S	White	3.0	105	105	V-1	-	-				E56745
	XE11-B5320	White	1.5	105	105	HB	-	-				E56745
		White	3.0	105	105	HB	-	-				
1 Part Heat Cure	TSE3051-FR	Clear	2.7-3.3	105	105	V-1	-	-				E56745
	TSE322S N	NC	1.0	105	105	HB	-	-				E56745
		NC	1.5	105	105	HB	-	-				
		NC	3.0	105	105	HB	-	-				
	TSE326	Red	1.0	105	105	HB	-	-				E56745
		Red	3.0	105	105	HB	-	-				
2 Part	TSE3331	Black	1.0	105	105	V-0	-	-	0	0	0	E56745
		Black	1.6	105	105	V-0	2	0				
		Black	2.0	105	105	V-0	-	-				
		Black	3.0	105	105	V-0	0	0				
	TSE3331K	Black	2.5	105	105	V-0	-	-				E56745
		Black	3.0	105	105	V-0	-	-				
	TSE3331K EX	Black	2.5	105	105	V-0	-	-				E56745
		Black	3.0	105	105	V-0	-	-				
	TSE3431	Gray	2.0	105	105	V-1	-	-				E56745
		Gray	4.0	105	105	V-0	-	-				
	TSE3431-H	Gray	1.0	105	105	V-0	0	0	0	1	1	E56745
		Gray	1.5	105	105	V-0	-	-				
		Gray	2.5	105	105	V-0	0	0				
		Gray	3.0	105	105	V-0	-	-				
	TSE3664K	Gray	1.0	105	105	V-1	-	-				E56745
		Gray	2.0	105	105	V-0	-	-				
		Gray	3.0	105	105	V-0	0	0				
	XE14-B7892	Black	2.0	105	105	V-1	-	-				E56745
Black		3.0	105	105	V-0	-	-					
TSE3661	All	1.0	105	105	HB	4	0			0	E56745	
	All	3.0	105	105	HB	3	0					
TIA222G	Gray	3.0 - 3.3	105	105	V-0	-	0	0	2	0	E56745	

HWI	HAI	HVTR	D495	CTI
Resistance to ignition when exposed to high temperatures. Expressed as the mean number of seconds required to ignite a specimen when wrapped with an energized ni-chrome resistive wire that dissipates a specified level of energy.	Ability to withstand electrical arcing. Expressed as the number of arc rupture exposures required to ignite a specimen when the arc occurs directly on the surface or a specified distance above the test specimen.	Expressed as the rate (inches per minute) that a tracking path can be produced on the surface of the material under standardized test conditions.	Expressed as the number of seconds that a material resists the formation of a surface-conducting path when subjected to an intermittently occurring arc of high voltage, low current characteristics.	Expressed as that voltage which causes tracking after 50 drops of 0.1% ammonium chloride solution have fallen on the material.
Mean Ignition Time (sec)	Mean No. of Arcs	HVTR Range (in mm/min)	Arc Resistance (sec)	Tracking Index (volts)
PLC	PLC	PLC	PLC	PLC
≥ 120	≥ 120	0 - 10	≥ 420	≥ 600
60 - 119	60 - 119	10.1 - 25.4	360 - 419	400 - 599
30 - 59	30 - 59	25.5 - 80	300 - 359	250 - 399
15 - 29	15 - 29	80.1 - 150	240 - 299	175 - 249
7 - 14	<15	>150	180 - 239	100 - 174
<7			120 - 179	<100
			60 - 119	
			<60	

# Typical Adhesion Performance

## Condensation Cure Grades

Substrate		Alkoxy				Acetoxy			Oxime			
		Primer-less	ME121	ME123	XP80-A5363	Primer-less	ME121	ME123	Primer-less	ME121	ME123	XP80-A5363
Metals	Copper	●	●			● <sup>1</sup>	● <sup>1</sup>		▲ <sup>1</sup>	● <sup>1</sup>		
	Steel	●	●			▲	●		●	●		
	Brass	●	●			▲ <sup>1</sup>	▲ <sup>1</sup>		▲ <sup>1</sup>	● <sup>1</sup>		
	Stainless Steel	●	●			▲	●		●	●		
	Aluminum	●	●			●	●		●	●		
	Galvanized Steel	●	●				●		●	●		
	Tin	●	●			●	●		●	●		
Plastic	Acrylic Resin	●		●		×		●	●	●		
	Phenol Resin	●		●		●		●	●	●		
	Epoxy Resin	●		●		●		●	●	●		
	Polycarbonate	●		●				●	●			
	Soft Polyvinyl Chloride	●		●		×		●	×	×	●	
	Rigid Polyvinyl Chloride	●		●		●		●	●	●	●	
	Polyester Film	●		●		▲		●	●	●	●	
	Unsaturated Polyester	●		●		●		●	●	●	●	
	Polyamide	●		●		●		●	●	●	●	
	Nylon 66	●		●				●			●	●
	PBT	●		●				▲			●	
	PPS	●		●				▲			●	●
	ABS	●		●		●		●	●	●	●	
	Polypropylene	×		×	●				×	×	×	●
	Polyethylene	×		×	▲	×		×	×	×	×	
	Fluorocarbon Resin	×		×		×		×	×	×	×	
Silicone Resin Laminate	●		●		●		●	●	●			
Rubber	Chloroprene Rubber	▲		●		▲		●	▲		●	
	Nitrile Rubber	▲		●		●		●	▲		●	
	Styrene Butadiene Rubber	▲		●				▲			●	
	Ethylene Propylene Rubber	▲		●				▲			●	
	Silicone	●		●		●		●			●	
Inorganic	Glass	●	●			●	●		●	●		
	Ceramic	●	●			●	●		●	●		

● Adheres completely, ▲ Adheres, but separates from surface when pulled, × Does not adhere  
<sup>1</sup> May corrode under some usage conditions

Primer Properties	Condensation Cure						Addition Cure		
	ME121	ME123	XP80-A5363	SS4004P	SS4044P	SS4179	ME151	XP81-B0016	SS4120
Appearance	Yellow Transparent	Yellow Transparent	Yellow Transparent	Pink	Yellow	Clear Colorless	Yellow	Yellow Transparent	Clear Colorless
Substrates	Metals, Glass, Plastic	Plastic, Rubber	Polyolefins	Metals	Metals	Plastic	Metals, Glass, Plastic, Ceramic	Metals, Glass	-
Specific Gravity (23°C)	0.85	0.86	0.88	0.85	0.85	0.98	0.87	0.71	0.82
Non-Volatile Content	15%	15%	7%	15%	15%	6%	24%	7.5%	3%
Drying Time (23°C) min	30	30	20	30	30	15	30	30	30
Solvents	Acetone Toluene IPA	Acetone Toluene IPA	Toluene	Acetone Xylene N-butanol IPA	Acetone Xylene N-butanol IPA	Ethyl Acetate Toluene Methanol	Toluene IPA	n-hexane	Ethanol Methanol



## Shear Adhesion Test Method

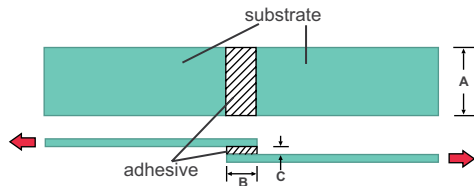

	JIS Method	ASTM Method
A:	25mm	1"
B:	10mm	0.5"
C:	1mm	-
Pull Rate:	10mm/min.	1"/min.

## Typical Chemical Resistance

	Chemical	Volume Change
Acid	Concentrated Hydrochloric Acid	⊙
	Hydrochloric Acid (3%)	⊙
	Concentrated Sulphuric Acid	Decomposition
	Sulphuric Acid (10%)	⊙
	Concentrated Nitric Acid	△
	Nitric Acid (7%)	⊙
	Glacial Acetic Acid	⊙
	Acetic Acid	⊙
	Hydrofluoric Acid	Decomposition
	Citric Acid	⊙
	Phosphoric Acid	⊙
	Alkali	Concentrated Ammonia
Ammonia (10%)		⊙
Potassium Hydroxide (20%)		⊙
Sodium Hydroxide (1%)		⊙
Sodium Hydroxide (20%)		⊙
Sodium Hydroxide (50%)		⊙
Inorganic Saline Solution	Sodium Chloride (10%)	⊙
	Sodium Carbonate (2%)	⊙
	Sodium Carbonate (20%)	⊙
	Hydrogen Peroxide (3%)	⊙
Oil	ASTM No.1 Oil (150°C, 70h)	⊙
	ASTM No.3 Oil (150°C, 70h)	△
	Mineral Oil	⊙
	Castor Oil	⊙
	Flax Seed Oil	⊙
	Silicone Oil (35°C, 70h)	△
Solvent	Acetone	△
	Butyl Alcohol	○
	Ethyl Alcohol	⊙
	Gasoline	X
	Mineral Spirit	X
	Toluene	X
Water	Water (room temperature)	⊙
	Boiling Water (70h)	⊙

⊙: <10%, ○: 10-25%, △: 25-75%, X: >75%

Test Method:

Volume change of cured silicone rubber after immersing 1 week at 25°C

## Typical Heat Resistance

### 1-Part Condensation Cure Adhesive (Alkoxy Type)

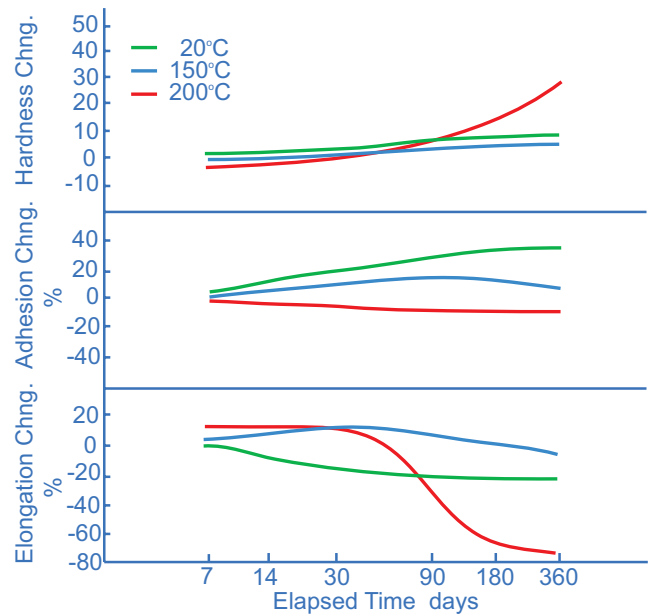

## Typical Electrical Performance

Dielectric Strength Test Method:

Equipment:  
Dielectric voltage gauge  
Voltage Rise:  
1kV/s  
Terminal Gap:  
1mm (JIS C 2110)

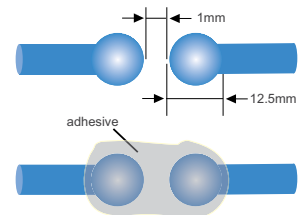

## Electrical Performance of Cured Material

TSE3843-W	Volume Resistivity MΩ·m		Dielectric Strength kV/mm	
	40°C, 95%RH	25°C Immersed	40°C, 95%RH	25°C Immersed
Initial	1.6x10 <sup>7</sup>	1.6x10 <sup>7</sup>	29	29
1 Day	2.9x10 <sup>6</sup>	2.2x10 <sup>6</sup>	27	25
3 Days	2.5x10 <sup>6</sup>	3.6x10 <sup>6</sup>	29	22
7 Days	2.7x10 <sup>6</sup>	1.9x10 <sup>6</sup>	24	23

## Other Electronic Solutions from Momentive Performance Materials



Provides detailed information on silicone materials used for thermal management applications in electronics and micro-electronics. Includes SilCool® grease & adhesives, and conventional grades for adhesion, encapsulation and potting.



Provides opto-electronic solutions for LED Packages and Assemblies. Includes InvisiSil® LED encapsulants, Glob Top, Lens fabrication materials, Die Attach adhesives, and Dot Matrix assembly materials.

## Frequently Asked Questions

### What does RTV mean?

RTV stands for Room Temperature Vulcanization (cure). Despite the low-temperature connotations conveyed by this name, RTV silicones consist of both Room Temperature Cure and Heat Cure grades.

### What is the cure mechanism of a condensation cure product?

Condensation cure silicone products cure when exposed to atmospheric moisture. Moisture in the air is generally required to cure (or vulcanize) condensation cure products. The cure process begins from the outer surface, and therefore time is required for complete cure. The cure time is affected by the reaction mechanism and viscosity of the material. Generally, at 25C and 50%RH, condensation cure RTV silicones cure through in 24 to 48 hours. Full physical properties may take up to 7 days to develop.

### What is the depth (bead thickness) limit for a condensation cure grade?

For 1-part, condensation cure products, the depth (bead thickness) limitation is approximately 6mm (1/4"). For 2-part, condensation cure products, the depth (bead thickness) limitation is approximately 25mm (1").

### Can I accelerate the cure time of a 1-part product?

Condensation cure silicone cure rates depend on humidity, silicone thickness, and to a smaller degree heat. Increasing the relative humidity around the silicone or reducing the thickness of the material will reduce the time to cure the material. Increased heat (not over 50C) will somewhat reduce cure time but as mentioned will do so to a much smaller degree than humidity or thickness.

### What is the cure mechanism of an addition cure product?

Addition cure silicone RTV products may be 1 or 2-part and cure when exposed to heat.

Although some heat cure products can cure at room temperature, higher heat greatly accelerates the cure. 1-part heat cure products typically have an inhibitor in the formulation that stops the product from curing until an activation temperature, greater than room temperature, is achieved and the inhibitor is driven off and the cure reaction is allowed to proceed.

### What does "tack free time" mean?

Tack free refers to the amount of time it takes for a condensation cure silicone product to form a cured outer layer (the cured outer layer is not tacky like uncured material).

### What is "mix ratio"?

Mix ratio is a term used to state the amount of each material to be in a multi-component material. The mix ratios for 2-part products are described on the individual product data sheets and are given as a ratio by weight of each material.

### What does "pot life" or "work life" mean?

The amount of time after a 2-part grade is mixed with its curing agent that it will remain useful or pliable.

### How do I remove silicone?

Before it is cured: use a putty knife to remove any of the uncured paste. Wipe the area clean with isopropyl alcohol to remove any leftover residue. After it is cured: First mechanically remove as much of the silicone as you can with either a knife or a razor. A solvent (mineral spirits, toluene, xylene, acetone) can then be used to remove any oily residue or any remaining silicone. It may be necessary to soak the silicone in a solvent overnight to break it down.

### Can I thin a silicone?

Silicone can be thinned using a solvent in which the silicone is miscible, generally an aromatic solvent such as toluene or xylene. As always, be sure to follow the producer's instructions when using solvent products and always use in a well-ventilated area. The shrinkage of the silicone and the cure time will increase with the addition of solvent. Alternative suggestions would include non-

reactive fluids or an RTV with a lower viscosity.

### What can I do to improve the adhesion of the silicone adhesive to my parts?

The first step to good adhesion is to have clean surfaces for the silicone to bond to. For difficult-to-bond-substrates, Momentive Performance Materials offers a number of primers that can be used to improve and maximize adhesion.

### How do I ensure that air is removed from 2-part grades?

If you are hand mixing, air may become added to the material during the mixing process. Vacuum de-airing is most effective in removing air prior to use. Automated mixing equipment that utilizes a static mixer can eliminate the need to de-air prior to dispensing.

On complex high-density electronics, air can sometimes be trapped under components during the potting process. Where this is a concern, potting under vacuum or vacuum de-airing after potting can remove the trapped air. An alternate approach may be to use a grade with a low viscosity and longer potlife and to cure at lower temperatures (if heat-cure grade), allowing entrapped air to escape prior to the cure of the material.

### What is cure inhibition, and how do I prevent it?

Cure inhibition is a phenomenon that may be observed in addition-cure grades. These materials use a platinum catalyst to drive the curing reaction. Surfaces containing water, sulphur, nitrogen compounds, organic metal compounds, or phosphate compounds, may inhibit cure.

Cure inhibition is characterized by a gummy or sticky appearance of the silicone at the interface between the silicone and offending substrate. Inhibition can be prevented by application of a barrier coat, cleaning of the offending material prior to application of the silicone material, replacing the offending material with a suitable alternative, or selection of a condensation cure grade.

## Dispensing Equipment Examples



Tube Type Dispensing Unit



Cartridge Type Dispensing Unit



Cartridge Air-Gun Dispensing Unit



Small Can Pump and Dispensing Unit



Pail Can Pump Unit

## Customer Service Centers

### Worldwide

4information@momentive.com

+1 614 986 2495 / T +1 800 295 2392

### North America

#### Silicones

T +1 800 332 3390

#### Consumer Sealants/

#### Construction Sealants and Adhesives

T +1 877 943 7325

### Latin America

#### South America

T +55 11 4534 9650

#### Mexico and Central America

T +52 55 2169 7670

### Europe, Middle East, Africa and India

T +00 800 4321 1000 / +40 21 3111848

### Pacific

#### China

T +800 820 0202 / +86 21 3860 4892

#### Japan

T +0120 975 400 / +81 276 20 6182

#### Korea

T +82 2 6201 4600

#### Malaysia

T +60 3 9206 1532

#### Patent Status

Nothing contained herein shall be construed to imply the nonexistence of any relevant patents or to constitute the permission, inducement or recommendation to practice any invention covered by any patent, without authority from the owner of the patent.

#### Product Safety, Handling and Storage

Customers should review the latest Material Safety Data Sheet (MSDS) and label for product safety information, handling instructions, personal protective equipment if necessary, and any special storage conditions required. MSDS are available at [www.momentive.com](http://www.momentive.com) or, upon request, from any Momentive Performance Materials representative. For product storage and handling procedures to maintain the product quality within our stated specifications, please review Certificates of Analysis, which are available in the Order Center. Use of other materials in conjunction with Momentive Performance Materials products may require additional precautions. Please review and follow the safety information provided by the manufacturer of such other materials.

#### Limitations

Customers must evaluate Momentive Performance Materials products and make their own determination as to fitness of use in their particular applications.

#### DISCLAIMER:

**THE MATERIALS, PRODUCTS AND SERVICES OF MOMENTIVE PERFORMANCE MATERIALS INC. AND ITS SUBSIDIARIES AND AFFILIATES (COLLECTIVELY "SUPPLIER"), ARE SOLD SUBJECT TO SUPPLIER'S STANDARD CONDITIONS OF SALE, WHICH ARE INCLUDED IN THE APPLICABLE DISTRIBUTOR OR OTHER SALES AGREEMENT, PRINTED ON THE BACK OF ORDER ACKNOWLEDGMENTS AND INVOICES, AND AVAILABLE UPON REQUEST. ALTHOUGH ANY INFORMATION, RECOMMENDATIONS, OR ADVICE CONTAINED HEREIN IS GIVEN IN GOOD FAITH, SUPPLIER MAKES NO WARRANTY OR GUARANTEE, EXPRESS OR IMPLIED, (i) THAT THE RESULTS DESCRIBED HEREIN WILL BE OBTAINED UNDER END-USE CONDITIONS, OR (ii) AS TO THE EFFECTIVENESS OR SAFETY OF ANY DESIGN INCORPORATING ITS PRODUCTS, MATERIALS, SERVICES, RECOMMENDATIONS OR ADVICE. EXCEPT AS PROVIDED IN SUPPLIER'S STANDARD CONDITIONS OF SALE, SUPPLIER AND ITS REPRESENTATIVES SHALL IN NO EVENT BE RESPONSIBLE FOR ANY LOSS RESULTING FROM ANY USE OF ITS MATERIALS, PRODUCTS OR SERVICES DESCRIBED HEREIN.** Each user bears full responsibility for making its own determination as to the suitability of Supplier's materials, services, recommendations, or advice for its own particular use. Each user must identify and perform all tests and analyses necessary to assure that its finished parts incorporating Supplier's products, materials, or services will be safe and suitable for use under end-use conditions. Nothing in this or any other document, nor any oral recommendation or advice, shall be deemed to alter, vary, supersede, or waive any provision of Supplier's standard Conditions of Sale or this Disclaimer, unless any such modification is specifically agreed to in a writing signed by Supplier. No statement contained herein concerning a possible or suggested use of any material, product, service or design is intended, or should be construed, to grant any license under any patent or other intellectual property right of Supplier covering such use or design, or as a recommendation for the use of such material, product, service or design in the infringement of any patent or other intellectual property right.

\*SilCool and InvisiSil are trademarks of Momentive Performance Materials Inc.

Momentive and the Momentive logo are trademarks of Momentive Performance Materials Inc.



260 Hudson River Road  
Waterford, NY 12188 USA  
[momentive.com](http://momentive.com)